

C2150 Control

with Version 11 Software

for Series

2000, 2000B, 2001 & 2003

Electric Slide Door Operators

SETUP INSTRUCTIONS & TROUBLESHOOTING

To be used with either G200, G2001, G230, G230T, G205 or G20B
Installation Instructions

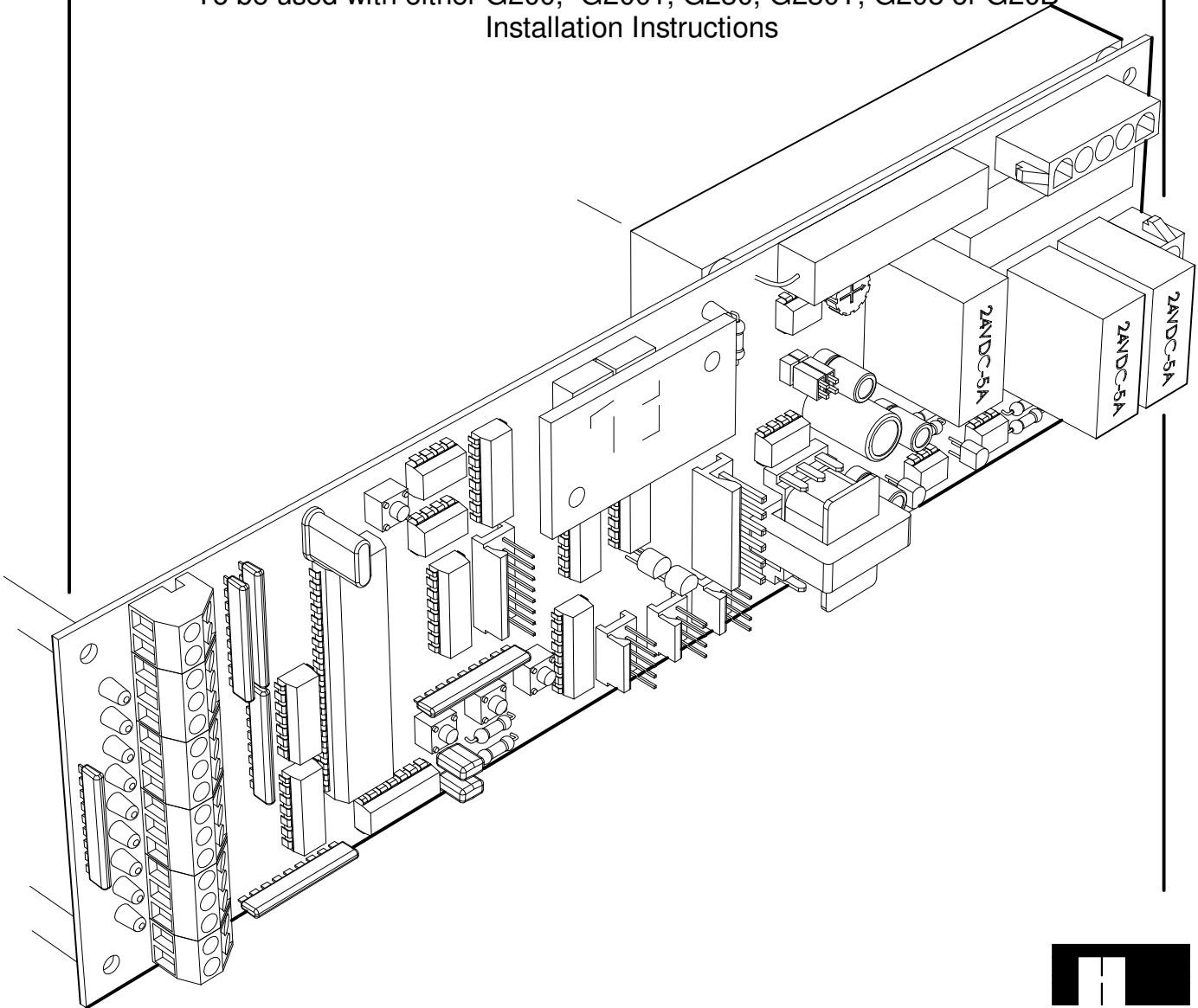

CONTENTS

SECTIONS

1. Slide Operator Instructions for Series 2000 Linear Drives & Series 2000B, 2001 & 2003 Belt Drives.....	H210.1
LINEAR DRIVE	
2. C2150 initialization (learn cycle)	H210.2
3. Adjusting parameters (Procedure for changing preset parameters).....	H210.3
4. Adjustable preset parameters (chart of adjustable ranges).....	H210.3
5. Actuation features.....	H210.4
6. Autolock initialization.....	H210.4
7. Setting lock parameters.....	H210.5
8. Lock error codes (Troubleshooting guide).....	H210.5
9. Autolock test points.....	H210.5
10. Autolock functions.....	H210.5
11. Microswitch diagnostics.....	H210.6
12. Partial open switch.....	H210.6
BELT DRIVES	
13. C2150 initialization (learn cycle).....	H210.7
13. C2150 initialization (learn cycle) cont.....	H210.8
14. Adjusting parameters (Procedure for changing preset parameters).....	H210.9
15. Actuation features.....	H210.10
16. Autolock initialization.....	H210.10
17. Setting lock parameters.....	H210.11
18. Lock error codes (Trouble shooting guide).....	H210.11
19. Autolock test points.....	H210.11
20. Autolock functions.....	H210.11
21. Encoder error codes.....	H210.12
22. Encoder diagnostics.....	H210.12
23. Encoder test points.....	H210.12
BELT DRIVE or LINEAR DRIVE	
24. Power failure units.....	H210.13
APPENDIX	
A. In case of difficulty (Troubleshooting the C2150).....	H210.14
B. Linear drive function test.....	H210.15
B1. Belt drive function test.....	H210.15
C. Code displays	H210.16
C2. Code displays, footnotes and short cuts.....	H210.17
D. Motor test.....	H210.18
E. Terminal CN2 (Description of terminal block connections).....	H210.18
WIRING DIAGRAMS	
1. Actuating and control switch connections.....	H210.19
2. Typical wiring for beams and switches.....	H210.20

1. SLIDE OPERATOR QUICK START INSTRUCTIONS FOR SERIES 2000 LINEAR DRIVES & SERIES 2000B, 2001 & 2003 BELT DRIVES

C2150 Control with version 10 software - S/N 08030006-_____

To get the operator up and running, check the items outlined below-

Do **NOT** wire any motion detectors or any other accessories at this time.
Factory pre-wired beams (pins 5,6 & 7) may be left in place.

1st Step

A toggle switch or jumper must be present between pins 8 & 9. Switches are sent loose and field mounted. Breakouts are wired in series with the toggle switch.

9th Step

Verify jumpers JB1A & JB1B

8th Step

Temporarily turn the reversing sensitivity completely counter-clockwise.

7th Step

Incoming voltages from power supply

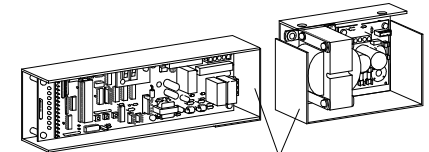
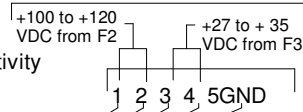

Shields and chassis are not shown in this manual for clarity

NOTE:
On 2001 & 2003 Metal shields are **REQUIRED** by UL for protection against high voltage areas
Do not remove.

2003 switch
2001 switch

CN 2

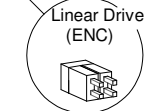

CN 7

CN 8

BLK
RED

TO MOTOR

GRN / YEL
motor ground

6th Step

A 5 conductor cable attaches CN7 to the power supply.

5th Step

Check that the incoming power is wired as shown.

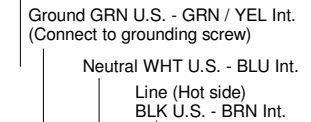

**FIELD WIRING
OPTION 1
AC POWER IN**

2nd Step

If the day / night mode is **NOT** to be used - there **MUST** be a jumper between 15 & 16. See Sections 5 thru 10 for actuating features and lock setup.

3rd Step

The encoder must be plugged into CN1 on the control.
(The Linear Drive must be plugged into CN11)

4th Step

The motor must be plugged into connector CN8

TO LINEAR DRIVE

TO ENCODER

TO AUTOLOCK

Field wiring options

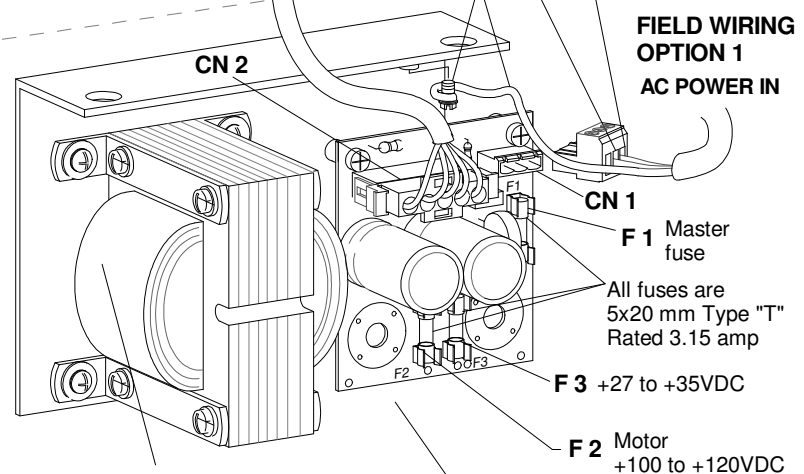
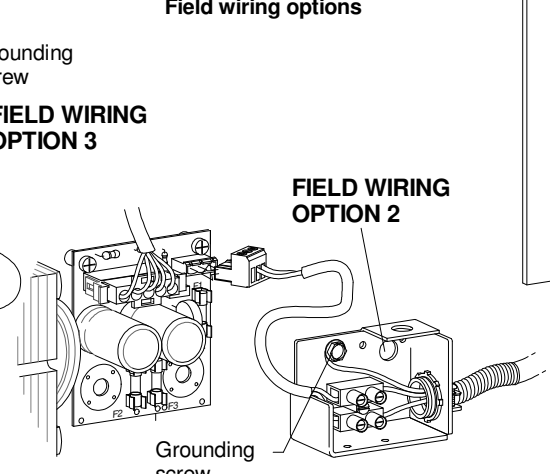
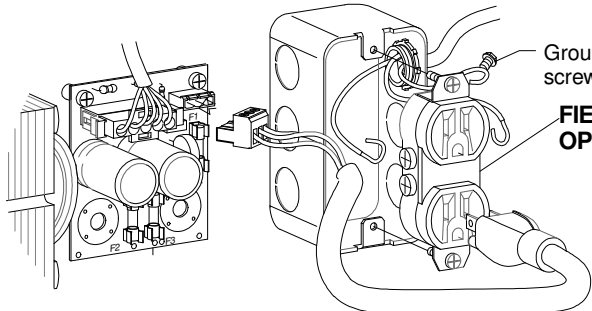

POWER SUPPLY
C3925 for 120VAC-2001 (shown)
C3955 for 120VAC-2003
C3926 for 240VAC-2001
C3956 for 240 VAC-2003

NOTE:
Component arrangement may vary.

IMPORTANT

With wiring option 1, 2 or 3 The main ground wire must be secured using the green grounding screw.

2000 LINEAR DRIVE

2. C2150 INITIALIZATION

1st Step - Power up

Be sure the toggle circuit is completed and apply AC power to the unit.

CAUTION: THE DOOR WILL MOVE.

2nd Step - Learn cycle

Instruct the control to perform a full learn cycle by:
 -Holding down the SET button and the RESET button.
 -Release the RESET button.
-Hold the SET button approximately 5 seconds until SU appears

3rd Step - Version display

The display should "blink" the version number (as in 11 then 00) *The display will show the lock code (see below)

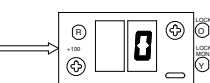
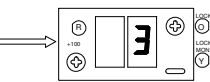
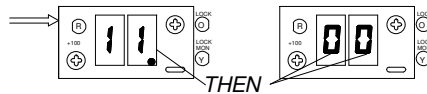
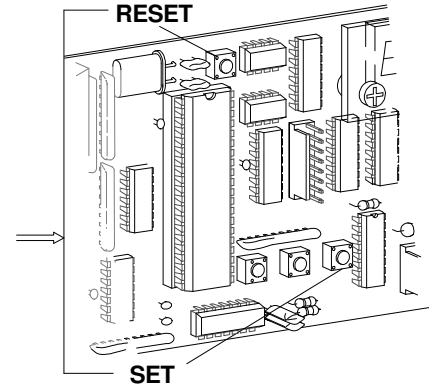

-The display should "blink" TY
 Then default to 3

-Press **DOWN** until **O** (zero) appears then press **SET**

*LOCK CODES

-The control will display **ONE** of the following lock codes depending the type of lock connected. (see Section 6)

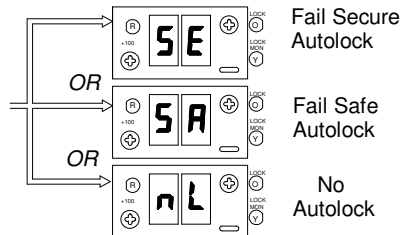

4th Step -Checking door cycle

When the toggle switch is on, the **DOWN** button acts as an actuation device.
The door will move - Be sure the safety beam area is clear of obstructions.
 Activation devices should not yet be installed.

Start with the door in the closed position.

Press the **DOWN** button to actuate the door to open at factory selected default settings.

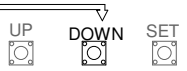

The chart below shows the position of the door and the display code for each position.

Inspect the unit for smooth operation, free of binds and excessive noise.

The follow cycles are carried out automatically by the C2150 control

-The display starts with:

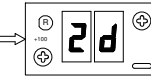

Open Cycle

-Open Speed

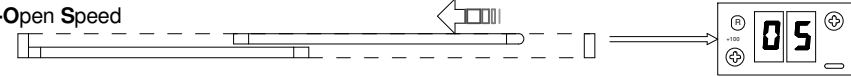

-Motor Braking



-Open Check *

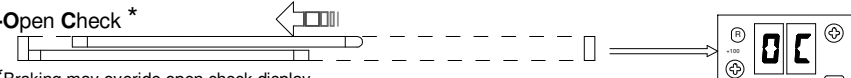

-Open cUshion



-Time Delay

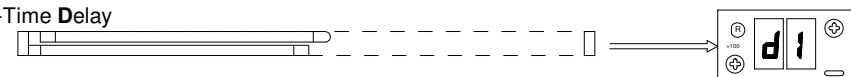

Close Cycle

-Close Speed

The closing speed should not exceed the rate of **1 ft / sec**

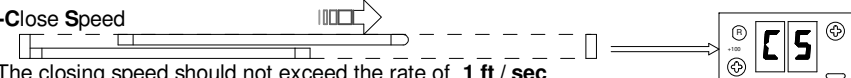

-Close Check

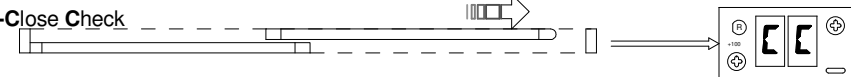

-Close cUshion



-The display returns to:

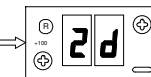

-If the above cycle check is OK and there are no parameters to be changed or an autolock to set up, this concludes the C2150 initialization.

IF THERE IS ANY DIFFICULTY SEE APPENDIX A

2000 LINEAR DRIVE

3. ADJUSTING PARAMETERS

9th Step - Changing parameter settings

A chart of preset values is shown to the right.
If any speeds or other settings need to be changed, follow this procedure:

-Turn the toggle switch **OFF**

Or, leave the toggle **ON** and double click the **SET** button when the door is fully open or closed.

-The display will switch to the menu of adjustable parameters

-The right decimal point will be blinking

-Refer to the chart in section 4 for a list of codes for adjustable parameters.

-Scroll through the parameter list using the **UP** and **DOWN** buttons until the parameter to be changed is found.

-When the parameter to be changed is found, press and hold the **SET** button.

-The display will show the current value or setting of the parameter.

-While holding the **SET** button, press the **UP** or **DOWN** button to modify the setting.

-When the **SET** button is released, the display will show the parameter that was just changed. Another parameter may be changed, or the toggle circuit turned on to check the changes just made. The **SET** button may be double clicked to exit the menu (toggle must be on).

10th Step -Saving new settings

-When all adjustments have been made and checked, be sure the toggle circuit is on.

-With the display reading **2d** press and **HOLD** the **SET** button until **dS** (data save) is displayed. All of the changes are now stored in the control's memory. **This step must be performed** or the control will revert to the default settings after a power failure.

-Set the reversing sensitivity as required using R10. **Do not** leave this adjustment at minimum. Horton recommends setting the sensitivity so the door will **reverse at 28 ft.lb.** or less.

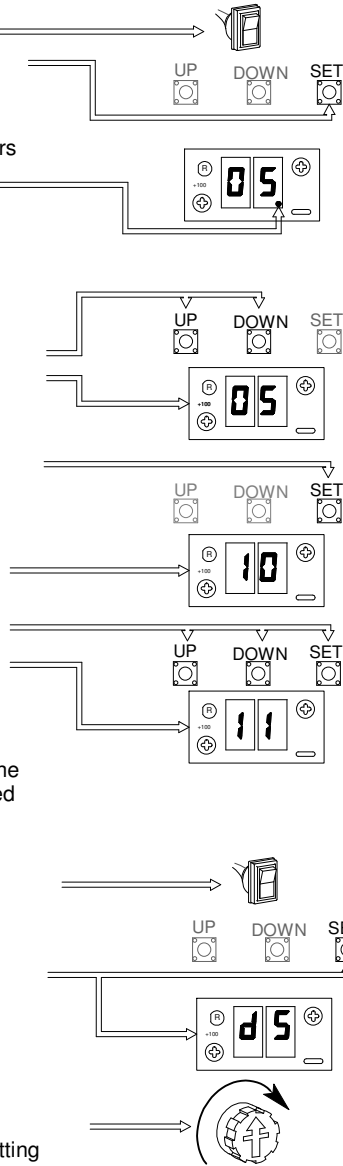

4. ADJUSTABLE PRESET PARAMETERS

The chart below shows all the adjustable parameters.
Follow the procedure outlined in step 9 to make any necessary changes.

CODE	PARAMETER	FACTORY PRESET VALUE	ADJUSTS
OS	Open Speed	10	0-15
CS	Close Speed	9	0-15
OC	Open Check	4	0-15
CC	CloseCheck	4	0-15
OU	Open cUshion	3	0-15
CU	Close cUshion	3	0-15
d1	full open delay	2 sec	60*
d2	partial open time delay	2 sec	60*
RC	Factory set - do not change)	1	Factory Set
HO	Factory set - do not change)	3	Factory Set
rC	Factory set - do not change)	3	Factory Set
cE	cycle test	oF	oF/on
AS	Auto Seal	oF	oF/on
rR	Reduced Accel	oF	oF/on
PF	Power Fail	OP (power fail OPen)	OP/CL
Pn	Power fail Night mode	on	oF/on
SL	Slow speed bank	oF	oF/on
Cb	Close braking	oF	oF/on
br	brake on recycles	on	oF/on
LL	Lock present	oF	oF/on
SA	fail- SA fe lock	oF	oF/on
UL	Unmonitored Lock	oF	oF/on
dL	daytime Lock	oF	oF/on
L1	Lock in 1-way	oF	oF/on
SP	Sidelite Protection	oF	oF/on
--	6 reserved parameters		
Lt	Longer Timeouts	oF	
--	2 reserved parameters		oF/on
nA	no Adjustment permitted	oF	oF/on
--	3 reserved parameters		
bE	brake time	20	0-100
--	1 reserved parameter		
EY	type (read only)	3	0-4
--	4 reserved parameters		

*Time delay is 2-8, 10, 12, 14, 16, 18, 20, 25, 30, & 60 seconds

2000 LINEAR DRIVE

5. ACTUATION FEATURES

Set jumpers or key switch for the type of operation required. See wiring diagram for actuation and control switch connections

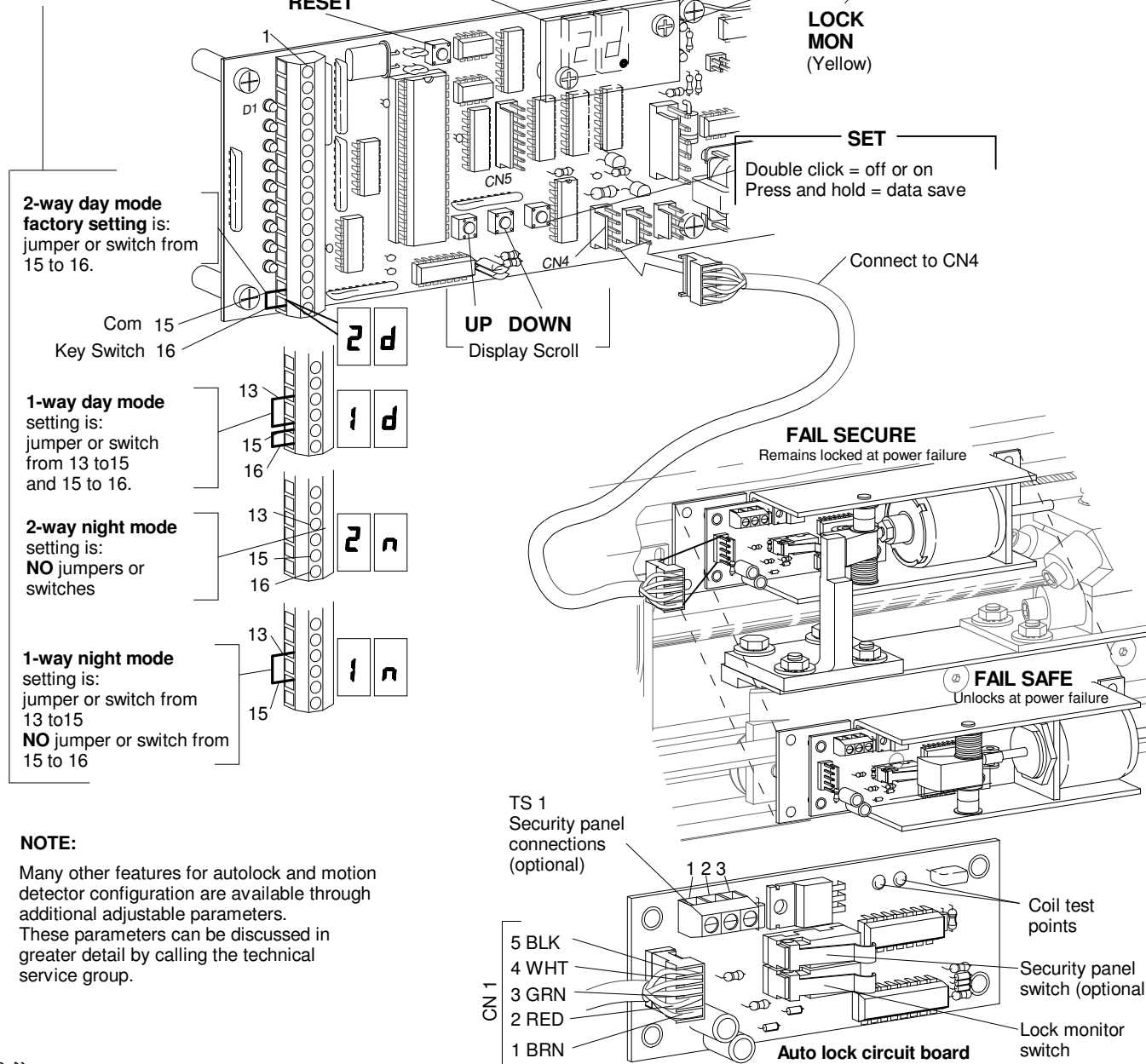

6. AUTOLOCK SET UP AND INITIALIZATION

Press **SET** and **RESET** simultaneously, release **RESET**, wait 5 seconds, then release **SET** - version number will displayed. During initialization the control clears all ports and the solenoid becomes inactive.

FAIL SECURE

The C2150 looks to see if there is a contact at the lock port CN4 and if the yellow lock monitor LED is off.

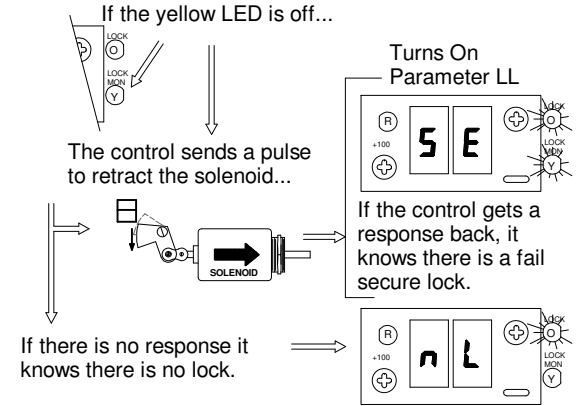

FAIL SAFE

The C2150 looks to see if there is a contact at the lock port CN4 and if the yellow lock monitor LED is on.

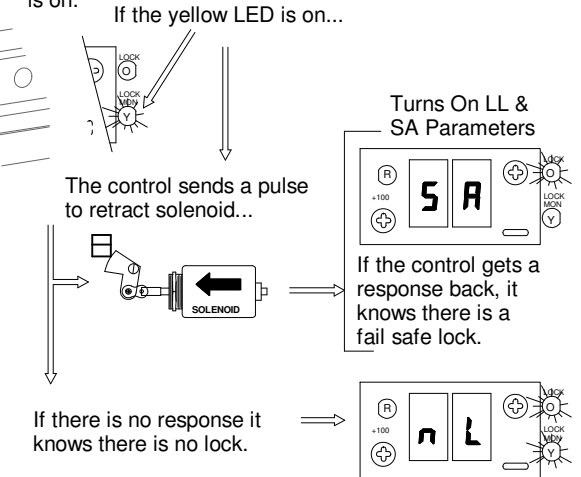

H210.4

2000 LINEAR DRIVE

7. SETTING LOCK PARAMETERS

Traffic Mode SEE STEP 1 FOR SET UP		dl:of L:of	dl:of L:on	dl:on L: doesn't matter
Day	2-Way	Unlocked	Unlocked	Locked
Day	1-Way	Unlocked	Locked	Locked
Nite	2-Way	Locked	Locked	Locked
Nite	1-Way	Locked	Locked	Locked

SEE SECTION 3 STEP 10 FOR (ds) DATA SAVE PROCEDURE

8. LOCK ERROR CODES

LF	Lock Failure (Fail Secure) Indicates that the lock monitor input is remaining active (lock monitor light is still on) even though solenoid has de-energized.
UF	UnLock Failure (Fail Secure) Indicates that the lock solenoid failed to move the plunger enough to activate the lock monitor switch and notify the control that the door is ready to be opened.
Check for mechanical binding. Check items under AUTOLOCK TEST POINTS and AUTOLOCK FUNCTIONS FOR FAIL SECURE autolocks.	
LF	Lock Failure (Fail Safe) Indicates that the lock solenoid failed to move the plunger enough to activate switch on the lock monitor.
UF	UnLock Failure (Fail Safe) Indicates that the lock solenoid spring has failed to move the plunger enough to activate the lock monitor switch and notify the control that the door is ready to be opened.
Check for mechanical binding. Check items under AUTOLOCK TEST POINTS and AUTOLOCK FUNCTIONS FOR FAIL SAFE autolocks.	

9. AUTOLOCK TEST POINTS

Basic voltage readings regardless of type. Set VOM at 200VDC.

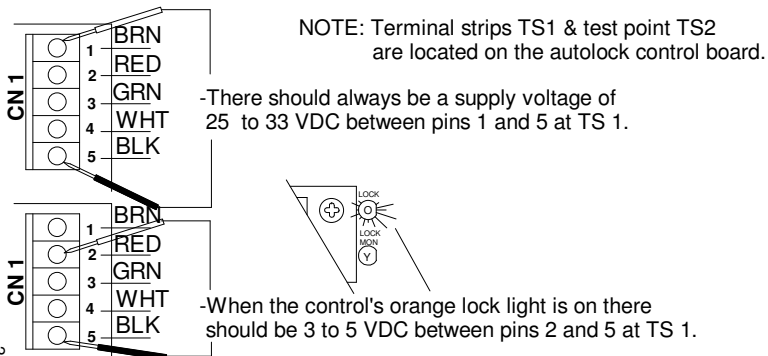

2.0472d
07/14

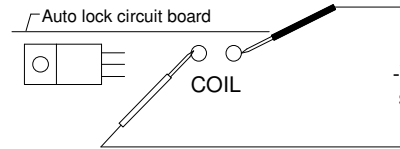

-When the solenoid initially energizes there should be 25 to 33 VDC at TS2.
After about a second the voltage will drop to about 30% of the supply voltage between pins 1 and 2 of TS2.

10. AUTOLOCK FUNCTIONS

The **FAIL SECURE** is the most common type of autolock used with the C2150.

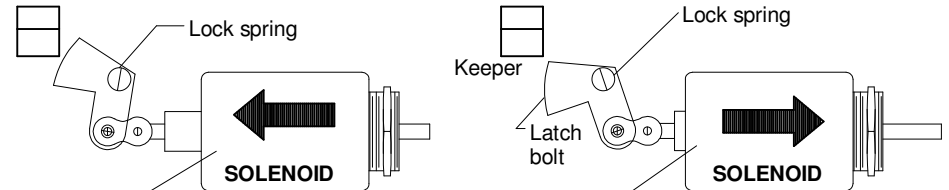

When power is removed, the solenoid is extended by the lock spring. The door is locked.

When power is applied the solenoid is retracted and the door is unlocked.

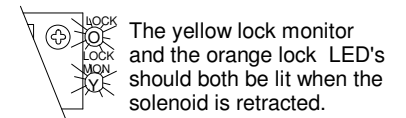
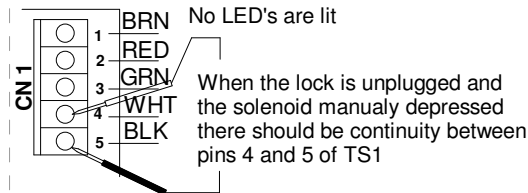

H210.5

The **FAIL SAFE** is a less common type of autolock used with the C2150.

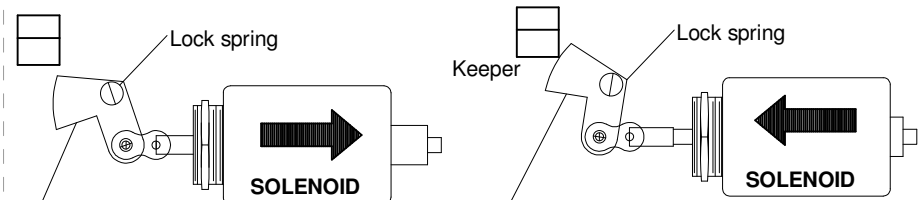

When power is removed the solenoid is retracted by the lock spring. The door is unlocked.

When power is applied the solenoid is extended and the door is locked.

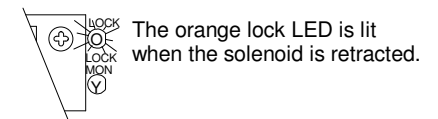
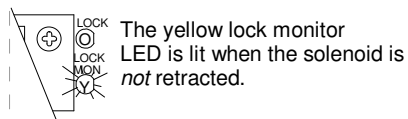

When the lock is unplugged and the solenoid is *not* manually depressed there should be continuity between pins 4 and 5 of TS1

11. MICRO SWITCH DIAGNOSTICS

Running a microswitch test

See diagnostics for functional test

Press the **RESET** & the **DOWN** button, release the **RESET** and hold the **DOWN** button until the display shows **U t**

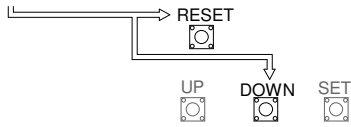

OR...

Power up the control while holding the **DOWN** button.

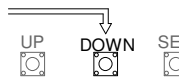

The display will, briefly, show **ut** (for microswitch test)

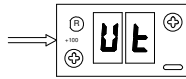

-Move the door manually through the open and closed positions to verify that each code is present for the position listed. (See the chart below)

-Missing codes, or codes that appear in improper order, indicate a problem with a switch assembly or a defective switch lace, or possibly the C2150.

-A blank display means that the door is in mid-stroke (no switches are tripped).

Open Cycle

-Open Check

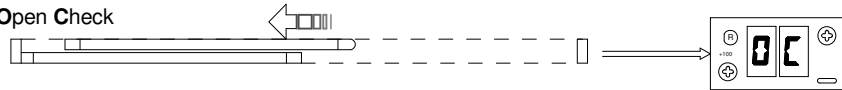

-Full OPen

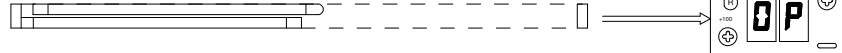

Close Cycle

-Close Check



-Fully CLosed

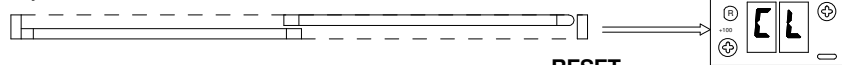

To exit the microswitch test press **RESET**



2000 LINEAR DRIVE

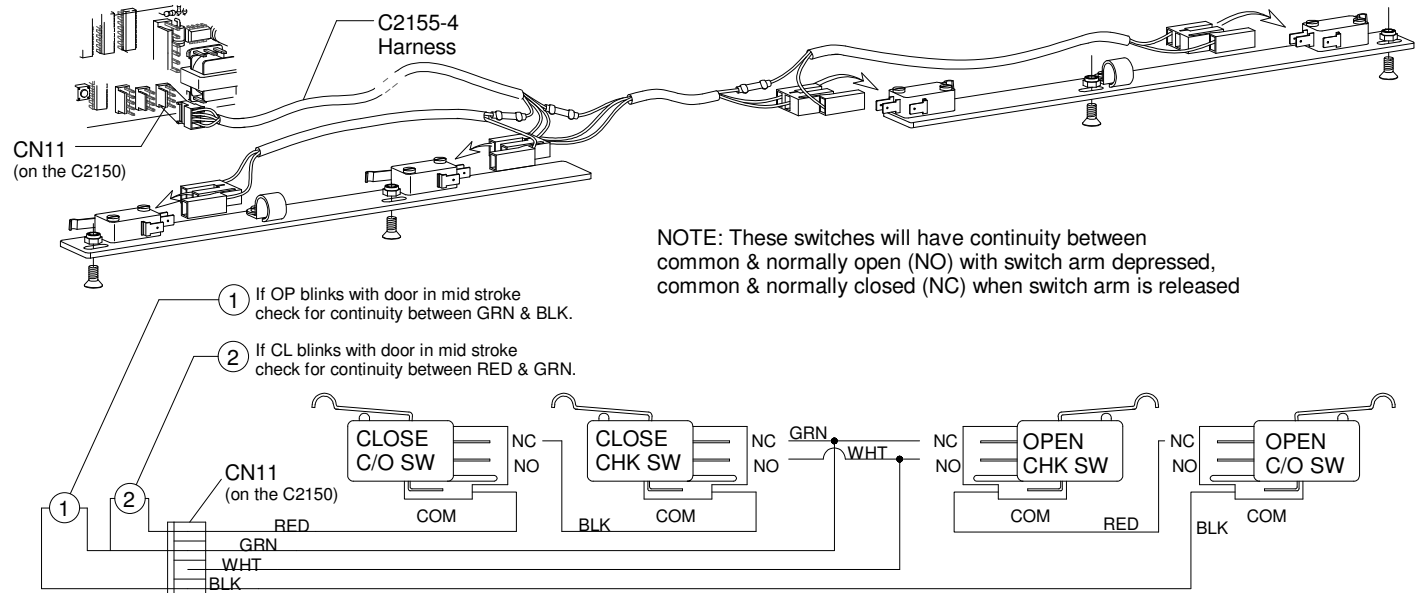

NOTE: These switches will have continuity between common & normally open (NO) with switch arm depressed, common & normally closed (NC) when switch arm is released

12. PARTIAL OPEN SWITCH

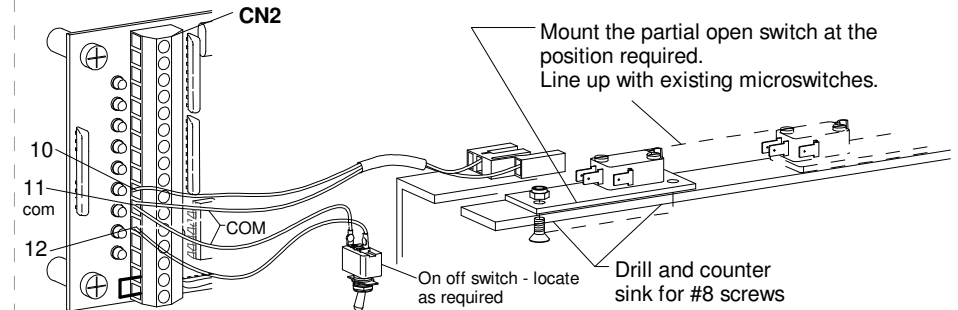

H210.6

BELT DRIVE

13. C2150 INITIALIZATION (learn cycle)

1st Step - Power up

Be sure the toggle circuit is complete and apply AC power to the unit.

CAUTION: THE DOOR WILL MOVE.

2nd Step - Learn cycle

Instruct the control to perform a full learn cycle by:
 -Holding down the **SET** button and the **RESET** button.
 -Release the **RESET** button.

-Hold the SET button approximately 5 seconds until SU appears.

3rd Step - Version display

VERSION 11

The display should "blink" the version number

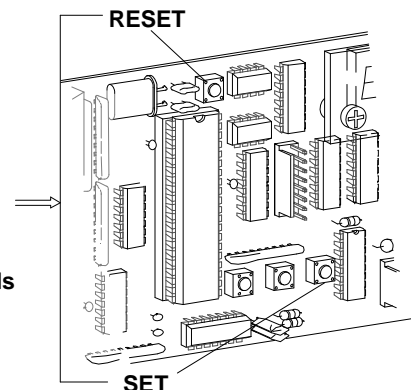

-The display goes blank for 3 seconds

-SU appears (set button can be released)

-TY flashes briefly

-Then defaults to 3

MOTOR TYPES

- 0 - Linear drive 2000 (see linear section)
- 1 - Merkle 2001 (10:1) 3.183" pulley 8ppr
- 2 - Litton 2001 (8.75:1) 3.183" pulley 8ppr
- 3 - Merkle 2003 (10:1) 2" pulley 8ppr
- 4 - Litton 2003 (10.5:1) 2" pulley 7ppr

-Press the **UP** or **DOWN** button to select the type.
 Then press **SET**.

LOCK CODES

-The control will display **ONE** of the following lock codes depending the type of lock connected. (see Section 17)

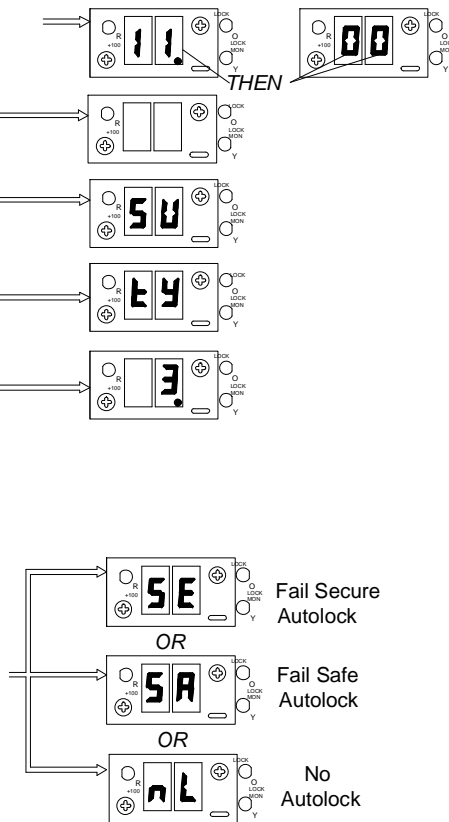

4th Step - Close stop

-The display should indicate **FC** (for first run - Finding Close stop) The door should fully close at slow speed.

-If the door moves a short distance then stops, and the display indicates **Pd**, the pre-wired safety beams or other actuating devices are stopping the door and preventing the "learn cycle".

-Pd can be overcome by holding the **UP** button until the door closes.

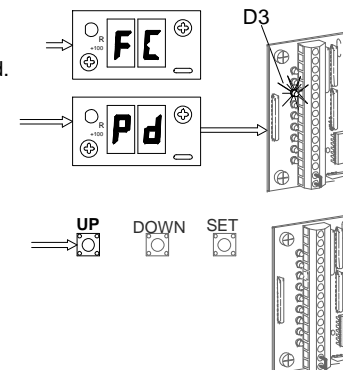

5th Step - Finding Open

-The display will show **F0**(Finding Open). The door will travel slowly open until it reaches full stroke. The stroke will be displayed in inches.

-TS is displayed indicating Total Stroke.

-If the stroke on the display is not the same as the actual stroke of the door, the wrong series type may have been selected.

6th Step - Day mode

-The display 2d (2-way daytime mode).

-If the display switches to something besides (2d) and the door refuses to do anything else....
CHECK

- The green TOG SW indicator on the control should be on.
- The toggle switch should be turned on. (between 8 & 9 on CN2)
- If there are SO panels, be sure the magnetic reed switches on the breakouts are closed.

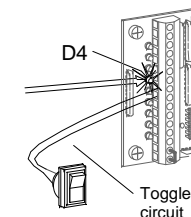

IF ANY OF THE CODES DEVIATE FROM THOSE SHOWN SEE APPENDIX B

H210.7

BELT DRIVE

13 (cont). C2150 INITIALIZATION (learn cycle cont.)

7th Step -Checking door cycle

When the toggle switch is on, the **DOWN** button acts as an actuation device.
The door will move - Be sure the safety beam area is clear of obstructions.
 Activation devices should not yet be installed.

Start with the door in the closed position.
 Press the **DOWN** button to actuate the door to open at factory selected default settings.

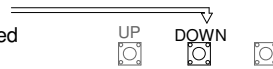

The chart (following) shows the position of the door and the display code for each position.

Inspect the unit for smooth operation, free of binds and excessive noise.

The following cycles are carried out automatically by the C2150 control

-The display starts with:

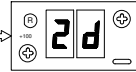

Open Cycle

-Open Speed

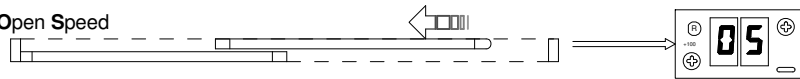

-Motor Braking

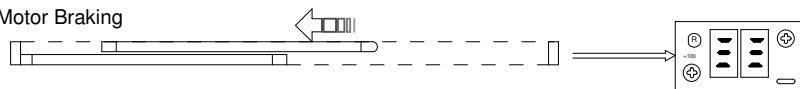

-Open Check *

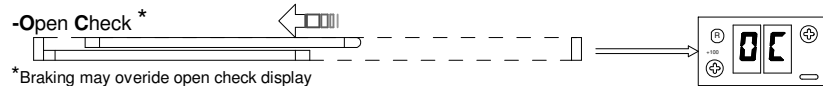

-Open cUshion



-Time Delay

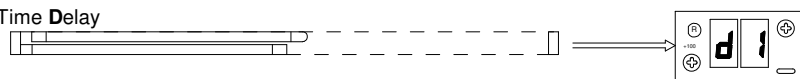

Close Cycle

-Close Speed

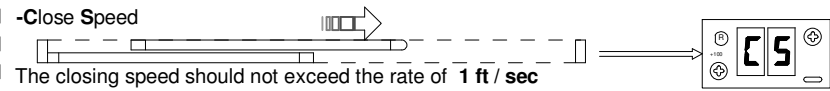

-Close Check



-Close cUshion

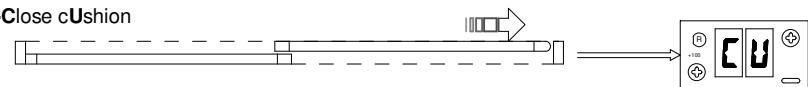

-The display returns to:



-If the above cycle check is OK and there are no parameters to be changed or an autolock to set up, this concludes the C2150 initialization.

IF THERE IS ANY DIFFICULTY SEE APPENDIX A

BELT DRIVE

14. ADJUSTING PARAMETERS

1st Step - Changing parameter settings

A chart of preset values is shown to the right.

If any speeds or other settings need to be changed, follow this procedure:

- Turn the toggle switch **OFF**
Or leave the toggle **ON** and double click the **SET** button.



- The display will switch to the menu of adjustable parameters

- The right decimal point will be blinking

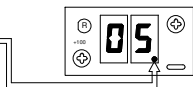

- Refer to the chart in section 4 for a list of codes for adjustable parameters.

- Scroll through the parameter list using the **UP** and **DOWN** buttons until the parameter to be changed is found.

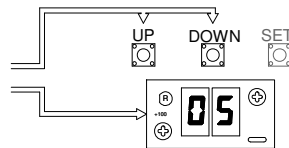

- When the parameter to be changed is found, press and hold the **SET** button.



- The display will show the current value or setting of the parameter.



- While holding the **SET** button, press the **UP** or **DOWN** button to modify the setting.

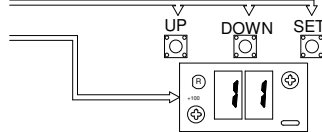

- When the **SET** button is released, the display will show the parameter that was just changed. Another parameter may be changed, or the toggle circuit turned on to check the changes just made. The **SET** button may be double clicked to exit the menu (toggle must be on).

2nd Step -Saving new settings

- When all adjustments have been made and checked, be sure the toggle circuit is on.

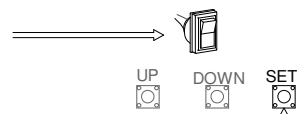

- With the display reading **2d** press and **HOLD** the **SET** button until **dS** (data save) is displayed. All of the changes are now stored in the control's memory. **This step must be performed** or the control will revert to the default settings after a power failure.

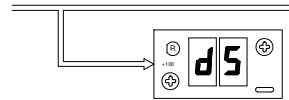

- Set the reversing sensitivity as required using R10. **Do not** leave this adjustment at minimum. Horton recommends setting the sensitivity so the door will **reverse at 28 ft.lb.** or less.

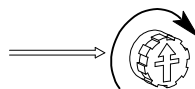

ADJUSTABLE PRESET PARAMETERS

The chart below shows all the adjustable parameters.

Follow the procedure outlined in step 1 to make any necessary changes.

CODE	PARAMETER	FACTORY PRESET VALUE	ADJUSTS
OS	Open Speed	10	0-15
CS	Close Speed	9	0-15
OC	Open Check	4	0-15
CC	Close Check	3 (4 in Series 2001)	0-15
OU	Open cUshion	3 (Note: Cushion is reduced speed; not a brake)	0-15
CU	Close cUshion	3 (2 in Series 2003)	0-15
d1	full open delay	2 sec	60*
d2	partial open delay	2 sec	60*
AC	factory set - do not change	1	
HQ	factory set - do not change	3	
rC	factory set - do not change	3	
ct	cycle test	oF	oF/on
AS	Auto Seal	oF	oF/on
rA	Reduce Accel	oF	oF/on
PF	Power Fail (open mode)	OP	OP/CL
Pn	Power fail Night mode	on	oF/on
SL	SLOw speed bank	oF	oF/on
cb	Close braking	oF	oF/on
br	brake on recycles	on	oF/on
LL	Lock present	oF	oF/on
SA	fail-SAfe lock	oF	oF/on
UL	Unmonitored Lock	oF	oF/on
dL	daytime Lock	oF	oF/on
L1	Lock in 1-way	oF	oF/on
SP	Sidelite Protection	oF	oF/on
--	4 Reserved parameters		
Rn	Restricts close speed to 1ft/sec	on	oF/on
St	No stop during Find Close mode	oF	oF/on
JS	Jam Sensing	on	oF/on
rP	reverse if no encoder Pulse	on	oF/on
LH	Left Hand parameter read only	on	oF/on
nA	no Adjustment permitted	oF	oF/on
--	1 Reserved parameter		
bt	brake time**	3***	0-3
Ob	Opening OBstruction detection	3 (factory set - most sensitive - 0 = off)	0-3
ty	TYpe (read only)	3	0-4
CP	Check Point in inches	90% of total stroke	
PO	Partial Open stroke in inches	8	
tS	total Stroke (read only)		

*Time delay is 2-8, 10, 12,14, 16, 20, 25, 30 or 60 seconds.

**This parameter changes the braking force during opening.

3 is the most forceful with 0 being the mildest

***Defaults: 2001 = 3 2003 = 1

BELT DRIVE

15. ACTUATION FEATURES

Set jumpers or key switch for the type of operation required. See diagram 2 page H202.16

2-way day mode factory setting is: jumper or switch from 15 to 16.

1-way day mode setting is: jumper or switch from 13 to 15 and 15 to 16.

2-way night mode setting is: NO jumpers or switches

1-way night mode setting is: jumper or switch from 13 to 15
NO jumper or switch from 15 to 16

NOTE:

Many other features for autolock and motion detector configuration are available through additional adjustable parameters. These parameters can be discussed in greater detail by calling the technical service group.

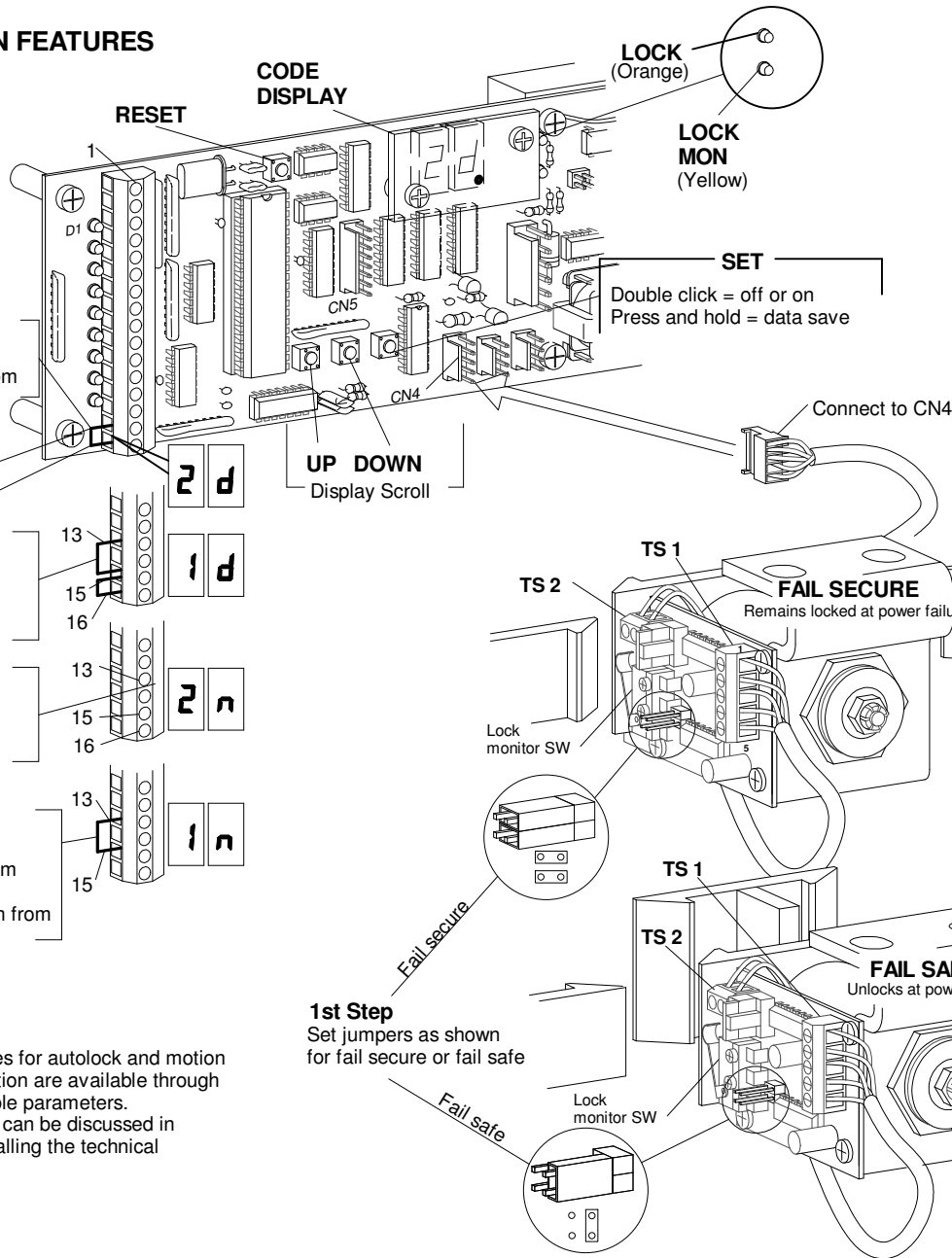

16. AUTOLOCK SET UP AND INITIALIZATION

Press **SET** and **RESET** simultaneously, release **RESET**, wait 5 seconds, then release **SET** - version number will displayed. During initialization the control clears all ports and the solenoid becomes inactive.

FAIL SECURE

The C2150 looks to see if there is a contact at the lock port CN4 and if the yellow lock monitor LED is off.

If the yellow LED is off...

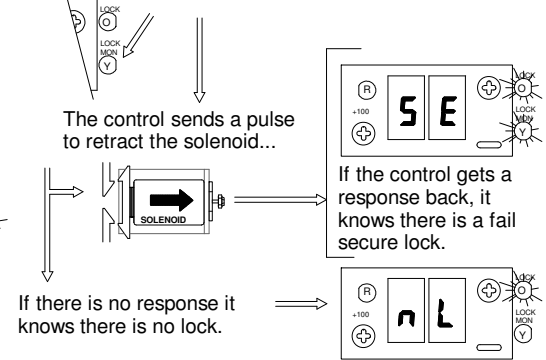

FAIL SAFE

The C2150 looks to see if there is a contact at the lock port CN4 and if the yellow lock monitor LED is on.

If the yellow LED is on...

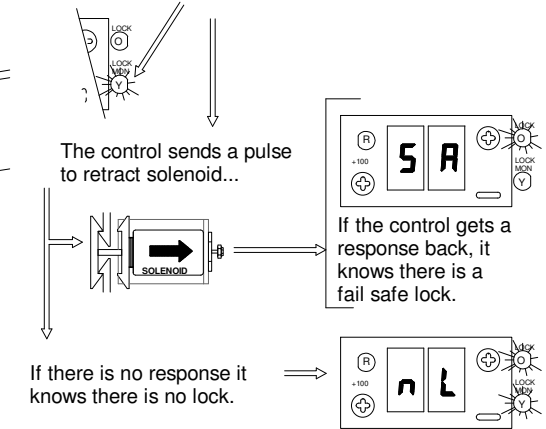

BELT DRIVE

17. SETTING LOCK PARAMETERS

To set up the lock parameters on the C2150 turn off the toggle circuit or double click the **SET** button. Use the **UP / DOWN** buttons to locate **dL** & **L1**. Press the **SET** button to display the **ON** or **OFF** setting. Set **dL / L1** as required from the table below.

Traffic Mode		dL : oF L1 : oF	dL : oF L1 : on	dL : on L1 : doesn't matter
Day	2-Way	Unlocked	Unlocked	Locked
Day	1-Way	Unlocked	Locked	Locked
Nite	2-Way	Locked	Locked	Locked
Nite	1-Way	Locked	Locked	Locked

SEE SECTION 3 STEP 10 FOR (ds) DATA SAVE PROCEDURE

18. LOCK ERROR CODES

LF	Lock Failure (Fail Secure) Indicates that the lock monitor input is remaining active (lock monitor light is still on) even though solenoid has de-energized.
UF	Unlock Failure (Fail Secure) Indicates that the lock solenoid failed to move the plunger enough to activate the lock monitor switch and notify the control that the door is ready to be opened.
Check for mechanical binding. Check items under AUTOLOCK TEST POINTS and AUTOLOCK FUNCTIONS FOR FAIL SECURE autolocks.	
LF	Lock Failure (Fail Safe) Indicates that the lock solenoid failed to move the plunger enough to activate the lock monitor switch.
UF	Unlock Failure (Fail Safe) Indicates that the lock solenoid spring has failed to move the plunger enough to activate the lock monitor switch and notify the control that the door is ready to be opened.
Check for mechanical binding. Check items under AUTOLOCK TEST POINTS and AUTOLOCK FUNCTIONS FOR FAIL SAFE autolocks.	

19. AUTOLOCK TEST POINTS

Basic voltage readings regardless of type. Set VOM at 200VDC.

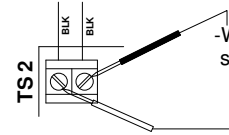
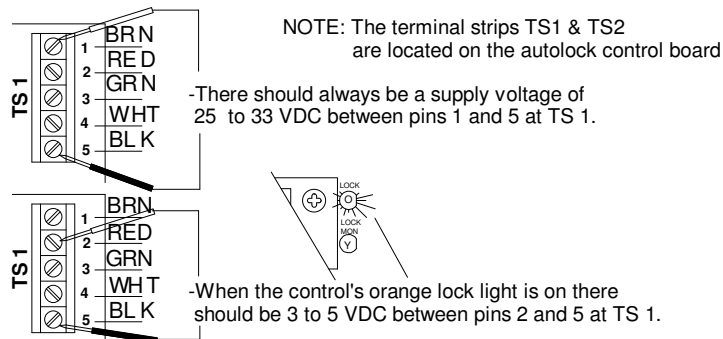

-When the solenoid initially energizes there should be 25 to 33 VDC at TS2. After about a second the voltage will drop to about 30% of the supply voltage between pins 1 and 2 of TS2.

20. AUTOLOCK FUNCTIONS

The **FAIL SECURE** is the most common type of autolock used with the C2150.

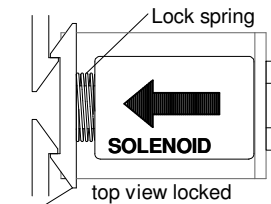

When power is removed, the solenoid is extended by the lock spring. The door is locked.

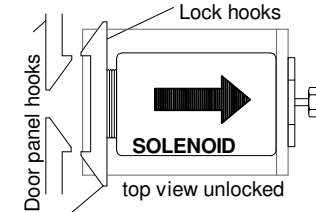

When power is applied the solenoid is retracted and the door is unlocked.

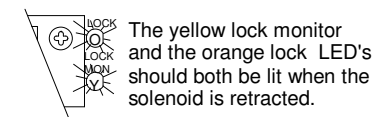
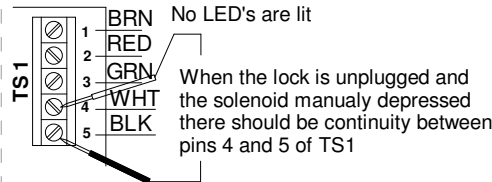

H210:11

The **FAIL SAFE** is a less common type of autolock used with the C2150.

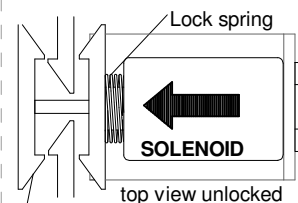

When power is removed the solenoid is extended by the lock spring. The door is unlocked.

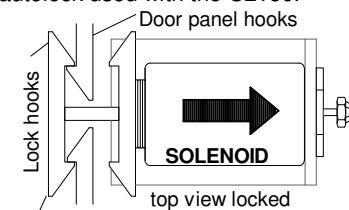

When power is applied the solenoid is retracted and the door is locked.

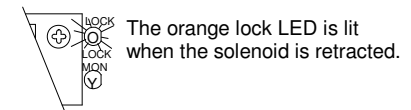
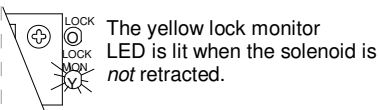

When the lock is unplugged and the solenoid is *not* manually depressed there should be continuity between pins 4 and 5 of TS1. Check the jumpers on the Autolock circuit board. (see section 6)

BELT DRIVE

21. ENCODER ERROR CODES

Encoder error codes are displayed when the door is running. Normally codes will be displayed at the end of a stroke or when a door stops abruptly during an "open" command.

Types of failure codes that could be displayed:

- EF** Encoder Failure - No pulses being received by the C2150.
-Check all connections to encoder and the control.
- LP** Loss of Pulses - All pulses required for proper operation were not received.
-See encoder test points Section 13

22. ENCODER DIAGNOSTICS

Encoder information is needed to provide consistent information on location, direction of travel, speed of door and door braking information to the C2150 control.

1st Step - Encoder test

- Press **RESET** and the **DOWN** button together
 - Release **RESET** and continue to hold the **DOWN** button until **ET** briefly appears - release the **DOWN** button.
- Following **ET** 2 short lines will appear. The test is ready to be performed.

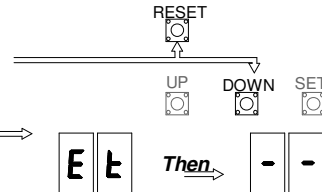

2nd Step - Performing test

View the display while manually moving the door **slowly** towards the open position. The display will show a counter clockwise rotation.

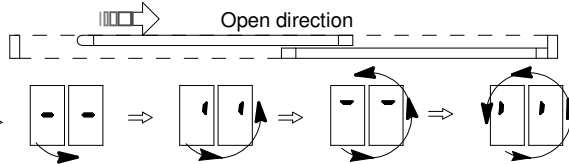

Manually move the door towards the closed position. The display will show a clockwise rotation.

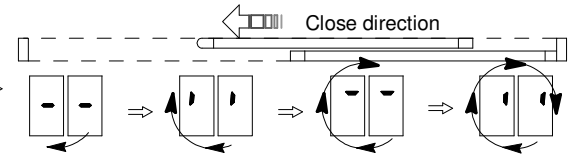

Each segment of 4 for a total of 8 segments should appear. No segment should be skipped. If anything occurs other than the description shown above the C2150 will get improper information and the door will not function properly.

23. ENCODER TEST POINTS

To test the encoder you will need a volt ohm meter (**VOM**) capable of reading DC Voltage.

Checking power and pulses

- Turn the toggle circuit off.

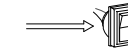

- Set the **VOM** to **200 DCV**

- Probe through the back of the red plug leaving it attached to CN 1.

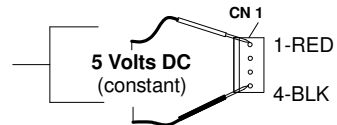

- To verify the encoder is producing pulses slowly move the door manually with the meter attached to 2 & 4 then 3 & 4. Watch the meter for 5 volt pulses.

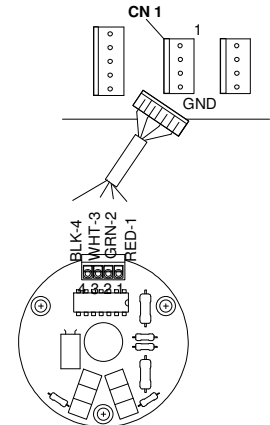
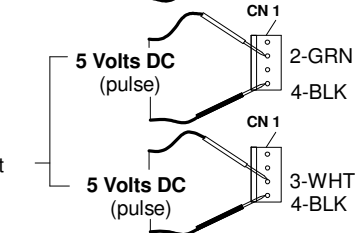

If the above voltages check out and the display does not rotate as shown in section 12 then contact the technical services group.

Checking connections

- Check JB 1. This circuit should be open - jumpers off as shown.

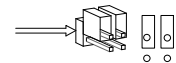

- Confirm that the encoder is plugged into CN1 and that the wires are connected to the plug.

Power but no pulse

There is power between pins 1 & 4 but there is no pulse between 2 & 4 or 3 & 4.

On the C5600 & C3675 only

- Remove the encoder cover and check that all wiring is secured in the terminal block.
 - Check the rotation of the encoder wheel as the door is moved manually.
 - Check the depth of the encoder wheel as it passes through the encoder optics.
 - If all visual inspections pass, the encoder board may have failed. Remove and replace.
- See appendix E**

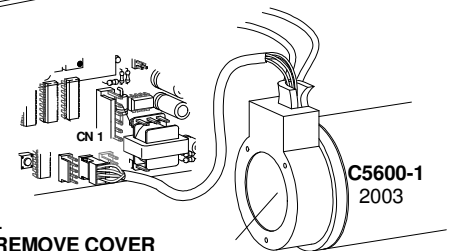
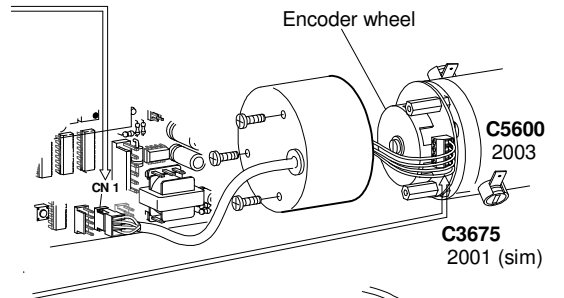

There are **no serviceable elements** on the C5600-1.

If the encoder fails replace the entire unit. **DO NOT REMOVE COVER**

BELT DRIVE or 2000 LINEAR DRIVE

24. POWER FAILURE UNIT C3984

The function of a power failure unit is to open or close the door (as selected) in the event of a power failure.

1st Step
Mount the unit in the header.

2nd Step
Connect the C3897 wiring harness from CN1 on C3984-2 to CN3 on C2150

4th Step
Go to the **PF** parameter in the C2150 (see section 4)
-Set to **OP** for the door to **open** when the power fails.
-Set to **CL** for the door to **close** when the power fails.
-To inhibit the power failure feature at night, go to the **Pn** parameter and turn it off.

3rd Step
Connect C3889 jumper from J1 on the C2150 to J1 on the power supply. This jumper connects to 24 VAC to power fail. If AC is absent power fail process is initiated.

The batteries could take up to 10 hours to charge before they can be tested.

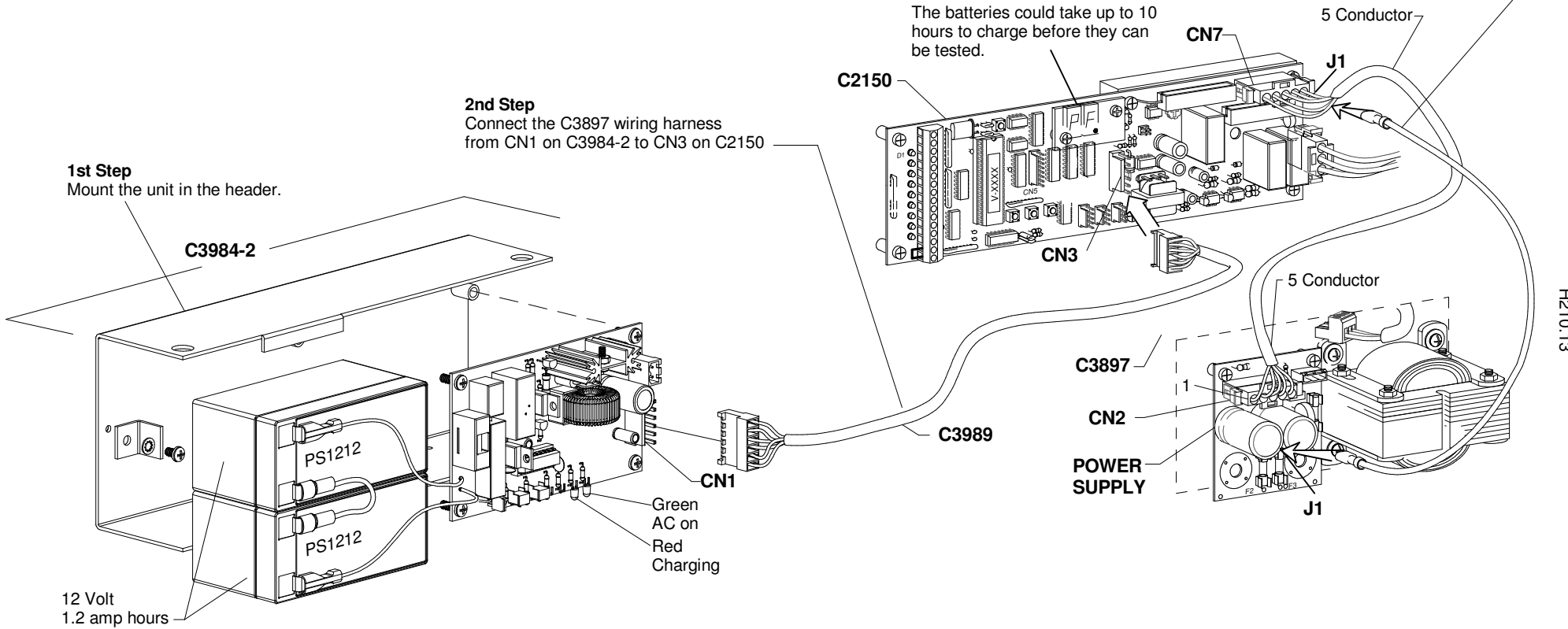

H210.13

BELT DRIVE or 2000 LINEAR DRIVE

APPENDIX A IN CASE OF DIFFICULTY

1.If DISPLAY FAILS TO LIGHT

- Go to section 1 step 8 and check for DC voltages shown on CN7 terminals 3 & 4.
- If voltage is **not present**, check AC power at pins 1 & 2 of CN1 of power supply.
- If AC power is **present**, check fuses F1 & F3 of the power supply.

2.If DISPLAY LIGHTS, BUT DOOR NEVER MOVES - PERFORM FUNCTION TEST

- Go to section 1 step 8 and check for DC voltages shown on CN7 terminals 1&2.
- If voltage is **not present**, check fuse F2 of the power supply.
- If F2 is good, power supply is faulty.
- If voltage is **present** on CN7 and display is showing a run code ie: **05.0U**, **CS**, **CC** or **CU** check for motor voltage (with motor plugged in) on pins 1 and 2 of CN8 leaving the control. Use 200 VDC scale.
- If voltage is **not present** at CN8, change control.
- If voltage is **present** at CN8, go to appendix C for motor test.

3.DOOR SLAMS OPEN and / or CLOSED WITH NO SPEED CONTROL

- Go to appendix C for motor test (to make sure motor did not ruin control)
- If motor test good, change control.

4.DISPLAY WILL ONLY SHOW OS

- Make sure toggle circuit is complete by turning toggle switch off and on. The green TSW LED should go off and come back on. This LED must be on for the door to operate.

5.ERROR CODE OR SOME OTHER ABNORMAL DISPLAY APPEARS.

- Go to appendix B - find the code and follow the instructions.

6.FUSE F2 BLOWS REPEATEDLY

- CAUTION:** disconnect the power supply at CN1 and wait 30 seconds before servicing.
- Unplug the power harness at CN7 (section 1 step 8) and the motor at CN8 and replace the fuse (slow blow 5 x 20mm Buss type GDC 3.15 or equal)
- If the fuse blows again, replace the power supply.
- If the fuse does not blow, reconnect the power harness at CN7 and attempt to operate the door with the motor unplugged.
- If the fuse blows now, replace the C2150 control (first check motor as shown in appendix C).
- If the fuse does not blow, plug the motor in and try again.
- If the fuse blows again and the motor checked good, check for a mechanical bind. Check **BR** and **JS** parameters in Appendix A which can help prevent fuse blowing.
- Consult Technical Assistance at the Horton factory.

7.FUSE F3 BLOWS REPEATEDLY

- CAUTION:** disconnect the power supply at CN1 and wait 30 seconds before servicing.
- Unplug the power harness at CN7 (section 1 step 8) and all connections of pins 1 and 5 of CN2 and CN4 autolock, if present, and replace fuse F3 again (slow blow 5 x 20mm Buss type GDC 3.15 or equal)
- If the fuse blows again, replace the power supply.
- If the fuse does not blow, reconnect the power harness to CN7.
- If the fuse blows now replace the C2150 control.
- If the fuse does not blow replace the autolock, and connections at pins 1 and 5 of CN2 one at a time until F3 blows indicating a short circuit in that component or its wiring. Beams and their wiring are the most frequent cause of F3 failure.

2000 LINEAR DRIVE

APPENDIX B LINEAR DRIVE FUNCTION TEST

-Press and hold **RESET**

-Press and hold **DOWN** and **SET**

-Release **RESET**

-Hold **DOWN** and **SET** until **Ft** appears
(note: version number will appear first)

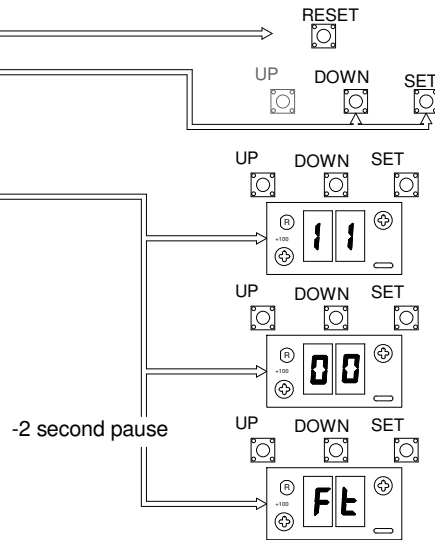

MICROSWITCH DISPLAY

-Press and hold the **UP** button to drive the door open.
The display will read as follows:

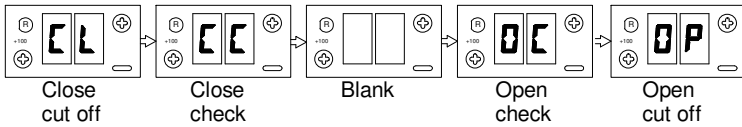

-Press and hold the **DOWN** button to drive the door closed.
The display will read as follows:

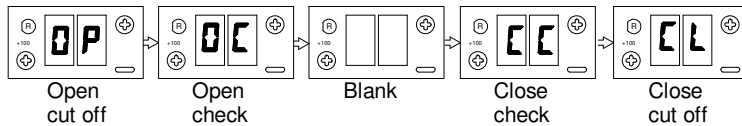

-Press the **SET** button to activate the lock

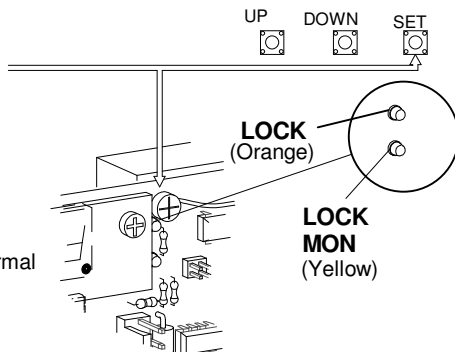

-Press the **RESET** to return the control to normal

BELT DRIVE

APPENDIX B1 BELT DRIVE FUNCTION TEST

-Manually move the door to mid stroke

-Press and hold **RESET**

-Press and hold **DOWN** and **SET**

-Release **RESET**

-Hold **DOWN** and **SET** until **Ft** appears
(note: version number will appear first)

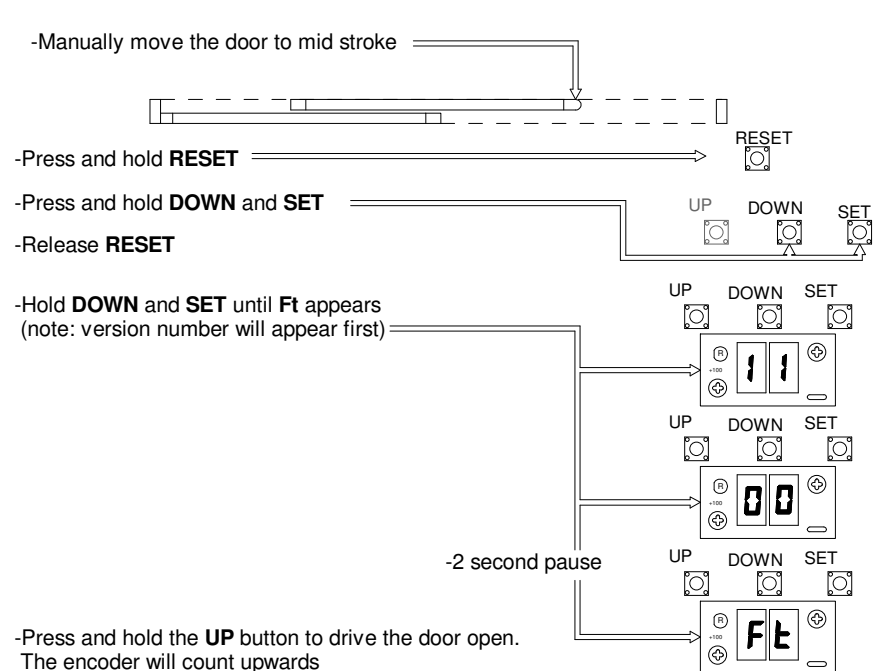

-Press and hold the **UP** button to drive the door open.
The encoder will count upwards

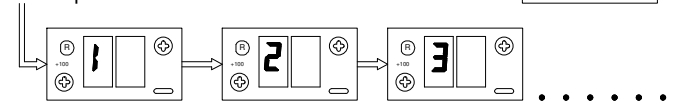

-Press and hold the **DOWN** button to drive the door closed.
The encoder will count down

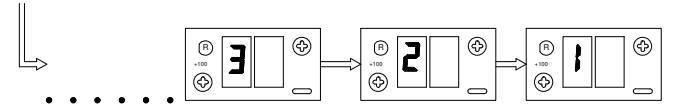

-Press the **SET** button to activate the lock

-Press the **RESET** to return the control to normal

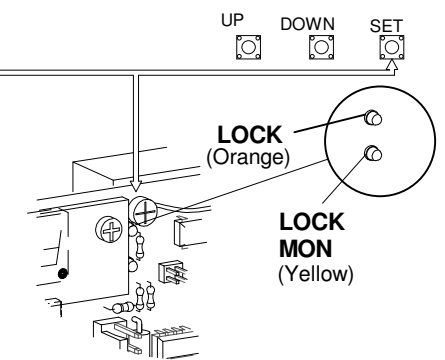

H210.15

APPENDIX C CODE DISPLAYS Codes are arranged in alphanumeric order (NOTE: D = Display, P = Parameter, E = Error)

CODE	DISPLAY MEANING	TYPE	VERSION
≡≡	Control is braking - door always brakes when opening. Close braking can be turned on at the Cb parameter	D	2.00 ↕
BB	Control has failed - must be replaced	E	2.00
1d	Door is idle in 1 way d ay mode. See section 5	D	2.19
1n	Door is idle in 1 way n ight mode. See section 5	D	2.19
2d	Door is idle in 2 way d ay mode. See section 5	D	2.19
2n	Door is idle in 2 way n ight mode. See section 5	D	2.19
AA	Door was activated or is being held open by SW 'C' input. See App. D CN2 for wiring & LED	D	2.15
AC	This parameter is factory set - do not change without consulting factory	P	2.00
AS	When Auto Seal parameter is turned on, the display will change to AS and the control will try to close the door every 15 seconds	PD	2.00
bF	This indicates battery failure of C3984 monitored power failure unit. See section 24	E	
br	Brake on recycle turned on, the control will slow door substantially before reversing on recycle	P	2.03
Cb	When close braking parameter is turned on, the control brakes the door between Close Speed and Close Check - recommended for heavy doors	P	2.03
CC	Close Check speed. See section 2 linear drive, section 13 belt drive	PD	2.00
CL	Power fail C lose see section 24	D	2.11
CP	This parameter determines stroke to open check. Adjustable from 50-90% of total stroke	P	2.00
CS	Close Speed . See section 2 linear drive, section 13 belt drive	PD	2.00
Ct	Cycle test will cause door to open and close repeatedly for test purposes	PD	
CU	Close Cushion speed. See section 2 linear drive, section 13 belt drive	PD	2.00
d1	Main time delay- starts when all activate and recycle inputs clear and door is fully open	PD	2.00
d2	Partial open delay is active when SW 'A' is on (App. D) & starts when all activate and recycle inputs have cleared & door is at partial open	PD	
dF	Control failed to store parameters (control must be replaced)	E	2.00
dL	Door Locks (in day mode) when this parameter is turned on. See section 7 linear drive, section 17 belt drive	P	2.00
dn	This is a cycle code (see footnote) from DOWN button	D	2.15
dS	This shows a successful Data Save. See section 3 step 10 linear drive, section 14 step 2 belt drive	D	
E1	Position error (belt drives)	E	2.11
ER	This is a cycle code (see footnote) from ext motec input see Appendix D CN2	D	2.15
EF	Encoder Failure. See section 21	E	2.00
EP	Encoder Phasing error.	E	2.02
Et	Brief display indicates start of encoder test.	D	2.00
FC	Finding Close is displayed when the door is closing to the fully closed position after a power failure or during learn initialization cycle. See section 13, 4th step	D	2.00 ↕
FO	Finding Open is displayed when the door is opening while counting encoder pulses. See section 13, 4th step	D	2.00 ↕
Ft	Function Test . See appendix B1	D	2.11 ↕
HO	This parameter is factory set - do not change without consulting the factory	P	2.00 ↕
IA	This is a cycle code (see footnote) from Interior Motec see Appendix D	D	2.15
J1	This indicates the control tried to run the motor & received no response from the encoder. The run was aborted to save the fuse(functional 2.09 & up)	D	2.07
JS	Turn on this parameter to save the fuse if the door is actuated while jammed or locked (see J1)	P	2.07
L1	Provides Locking in 1 way mode. See section 7 linear drive, section 17 belt drive	P	2.03
LF	Automatic Lock Failed to lock. See section 8 linear drive, section 18 belt drive	E	2.00 ↕
LL	On if lock is present. See section 6 linear drive, section 18 belt drive	P	2.18
LP	Indicates Loss of Pulses from encoder. See section 21	E	2.00 ↕
nR	Access restricted call factory for assistance	PD	2.05 ↕
nh	Position error. No home found (belt drives)	E	2.11 ↕
nL	No Lock found during initialization. See section 6 linear drive, section 16 belt drive	D	2.00 ↕
nS	Door has not reached appropriate switch in linear drive	E	2.06
Ob	OB struction - If door is impeded while opening / stops displays Ob and opens in OC	PD	2.22 ↕
OC	Open Check speed. See section 2 linear drive, section 13 belt drive	PD	2.00 ↕
OP	This is a Power fail Open code. See section 24	D	2.11 ↕
OS	Open Speed . See section 2 linear drive, section 13 belt drive	PD	2.00 ↕

H210.16

APPENDIX C2 CODE DISPLAYS

CODE	DISPLAY MEANING	TYPE	VERSION
OU	Open cUshion speed. See section 2 linear drive, section 13 belt drive.	PD	2.00 ↕
PC	Indicates control is slowing for partial open	D	2.00 ↕
Pd	Set up has stopped because of activation devices (see sect 2 step 5)	D	2.00 ↕
PF	Power Failure (see sect. 24)	PD	2.00 ↕
Pn	This parameter determines whether Power Fail Open or Power Fail Close works in Night Mode.	P	2.13
PQ	This parameter determines Partial Open stroke in inches.	P	2.00
rC	This parameter is factory set - do not change without consulting factory	P	2.00
rP	This parameter causes the door to recycle if open pulses are received during closing cycle	P	2.06
rU	This is a cycle code (see foot note) from reverser circuit.	D	2.18
SA	Indicates fail SAfe lock is found during initialization. See section 6 linear drive, section 16 belt drive. Parameter should be turned on if a fail safe lock is present.	PD	2.00 ↕
Sb	This is a cycle code (see foot note) from safety beam input. See section 6 linear drive, section 16 belt drive.	D	2.18
SG	Stroke Good.	PD	2.11 ↕
SE	Indicates fail SEcure lock is found during initialization (see sect. 6)	D	2.00 ↕
SF	Encoder failed during initialization. Do encoder test (see sect. 12)	E	2.00 ↕
SL	This parameter reduces all open speed values when turned on	P	2.18
SD	Stroke zeroed is displayed after forcing relearn (see short cuts)	D	2.00
St	Disables Pd during initialization	P	2.00 ↕
SP	Provides Sidelite Protection when turned on. Reduces opening speed to open check when safety beam input is activated (see app D)	P	2.03
SU	Displays at beginning of initialization	D	2.19
ES	Total stroke shown in inches at the end of initialization (read only)	PD	2.00 ↕
EY	Displays door type. Read only unless in set up mode.	PD	2.15 ↕
UF	Autolock has failed to unlock. See section 8 linear drive, section 18 belt drive	E	2.00
UL	When this is turned on it tells the software not to wait for the lock monitor but try to open after a brief delay. Rarely used, only for non Horton locks	P	2.00

H210.17

FOOT NOTES: APPENDIX D

-The latest versions, 2.15 and up, also have a new feature called cycle / hold codes. Immediately after the door has opened to its stopping point (full or partial open), a "cycle code" will flash briefly. This code indicates which device opened the door. The cycle code is useful if a door is ghosting and you are trying to figure out which activating device is causing the problem.

-If an actuator is holding the door open, the updated software shows a "hold code" instead of **d1** or **d2**, to indicate which device is holding the door open. The displays shows the various hold codes in sequence. When all devices are clear, the display will switch to **d1** or **d2** and the normal time delay will start.

The cycle / hold codes used are:

IA Interior Actuator (pin 2 of CN 2)	dn down button
Sb Safety beam (pin 6 of CN 2)	AA Auxiliary Actuator (pin 14 of CN 2)
EA Exterior Actuator (pin 3 of CN 2)	rU ReVerser (cycle code only)

-While the door is at rest in the open position, pressing and holding the **UP** button will switch the display to show the last cycle code; that is, the last device that cycled (or recycled) the door. Releasing the **UP** button takes you right back to normal operation. This is a kind of "mini-history" in case you didn't see the cycle code when the control flashed it the first time.

SHORT CUTS

SELF CYCLE MODE To initiate self cycle without accessing the **ct** parameter press and hold the **UP** button then press the **DOWN** button and release them at the same time. If you haven't saved any parameters, you can get out of this mode by pressing the **RESET** button only. Otherwise you must go to the **ct** parameter and turn off and do a data save.

CYCLE DOOR Push the **DOWN** button. The door will open, and stay open until **d1** expires and then close.

LEARN NEW STROKE ONLY (Version 2.03 and later) Hold **SET** and **UP** buttons. Press and release **RESET**, continue holding **SET** and **UP** buttons for 5 seconds. The door will go through the learn cycle without resetting any other parameters.

OVERRIDE PD (Version 2.11 and later) If you encounter "**Pd**" (or other hold codes) during initialization procedure, press and hold the **UP** button to override "**Pd**" and allow the door to set up. This prevents you from having to disconnect motecs or safety beams.

RETURN TO THE TOP OF THE MENU (Version 2.10 and later) Press **UP** and **DOWN** together to return to the top of the menu.

PARAMETER ACCESS (Version 2.12 and later) The menu may be accessed and parameters changed by rapidly double clicking the **SET** button when the door is fully closed or opened. To exit double click the **SET** button again and the control will return to normal mode. Turning the toggle off and on will override this function.

FORCED RELEARN To be absolutely sure that you have executed a relearn of the stroke, hold the **UP, DOWN** and **SET** buttons, then press **RESET** - hold for 5 seconds and release. The display will then start to flash **SD** and will continue to do so until the **RESET** button is pressed again. Then the control will execute a relearn as described in section 2 step 3.

APPENDIX D MOTOR TEST

This test is conducted to determine the resistance across the motor. A low or zero resistance will cause high current draw and damage to the control.

-Place OHM meter in range to measure :
10 to 50 Ω analog Rx1 range
R200 Ω digital.

-Unplug the motor and place probes in pins 1 and 2

-Read and record the resistance.

-Rotate the motor a little bit to move to the next section of the commutator.
(Feel for the brushes to make contact with the next segment on the commutator.)

-NOTICE: a voltage will be induced into the meter when the motor is moved, so wait for the meter to stabilize before taking a reading.

-Continue taking readings for about 1/4 revolution of the output pulley. (Pulley is 8:1 ratio)

-Acceptable ranges are shown by each motor type.

NOTE: A low reading is critical and will cause damage to the control.

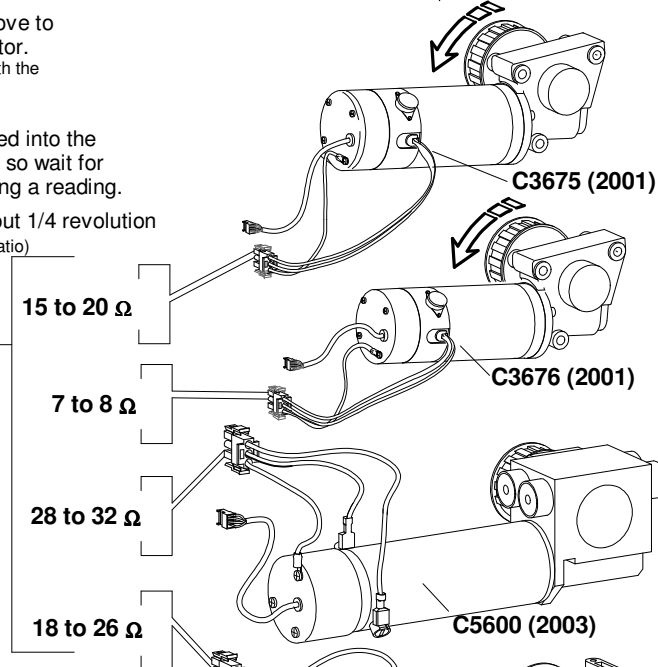
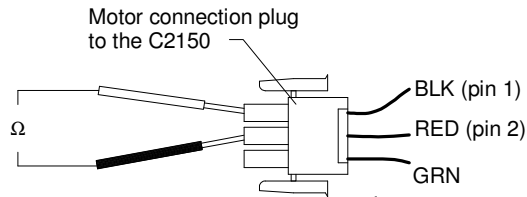

FRAME SHORT TEST

-Place the OHM meter in the range to measure at least 20,000 Ω
The meter should show infinite resistance when connected .

-Place probes in pins 1 (BLK) & 3 (GRN/YEL)

THEN... The meter should not move when the probes are connected.

-Place probes in pins 2 (RED) & 3 (GRN/YEL)

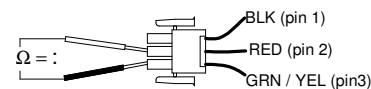
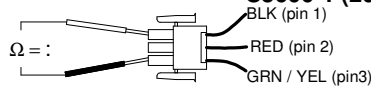

APPENDIX E TERMINAL CN2

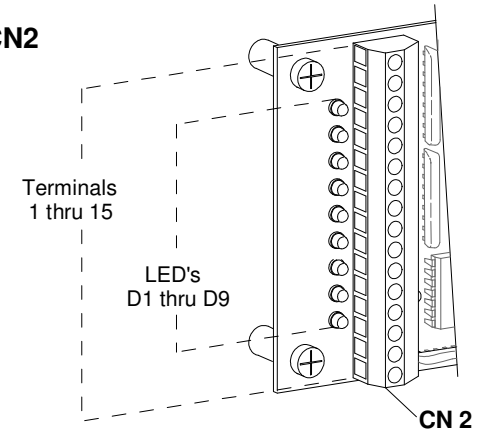

NOTE:

== This symbol indicates 24 volts DC

4. A point behind a number indicates common (ground)

LED	TERMINAL	DESCRIPTION
	== 1	24 VDC
D1 (G) INT MOT	2	Interior Activation
D2 (R) EXT MOT	3	Exterior Activation
	4.	Common
	== 5	24 VDC
D3 (Y) SAF BEM	6	Safety beam & sidelite protection
	7.	Common
D4 (G) TOG SW	8	Toggle switch
	9.	Common
D5 (Y) CLS MON	10	N/A
	11.	Common
D6 (G) SW A	12	Partial open cutoff
D7 (Y) SW B	13	1 Way (Closed for one way- light on)
D8 (R) SW C	14	Auxillary activation
	15.	Common
D9 (O) KEY SW	16	Day night mode (closed for day mode-light on)

DIAGRAM 1 ACTUATING and CONTROL SWITCH CONNECTIONS

APPROACH & SAFETY COMBINED:

(X-ZONE REQUIRES DIPSWITCH 13 "ON"; IXIO REQUIRES F1 [REDIRECTION] = 1)

INTERIOR SENSOR

CIRCUIT DESC.	X-ZONE (C1250)	IXIO* (C1248)	iONE (C1238)	C2150 TERM.
POWER	GRAY	RED	GRAY	#1
POWER	GRAY	BLACK	GRAY	#4
ACT, COM	WHITE	WHITE	WHITE	#4
ACT, NO	YELLOW	GREEN	YELLOW	#2
ACT, NC	GREEN	----	GREEN	N/C
SAF, COM	WHT/STRP	BRN	----	N/C
SAF, NO	YEL/STRP	BLU	----	N/C
SAF, NC	GRN/STRP	----	----	N/C

EXTERIOR SENSOR

CIRCUIT DESC.	X-ZONE (C1250)	IXIO* (C1248)	iONE (C1238)	C2150 TERM.
POWER	GRAY	RED	GRAY	#1
POWER	GRAY	BLACK	GRAY	#4
ACT, COM	WHITE	WHITE	WHITE	#4
ACT, NO	YELLOW	GREEN	YELLOW	#3
ACT, NC	GREEN	----	GREEN	N/C
SAF, COM	WHT/STRP	BRN	----	N/C
SAF, NO	YEL/STRP	BLU	----	N/C
SAF, NC	GRN/STRP	----	----	N/C

APPROACH & SAFETY SEPARATED:

(X-ZONE REQUIRES DIPSWITCH 13 "OFF"; IXIO REQUIRES F1 [REDIRECTION] = 0)
NOTE: THE iONE DOES NOT HAVE A SEPARATE SAFETY OUTPUT.

INTERIOR SENSOR

CIRCUIT DESC.	X-ZONE (C1250)	IXIO* (C1248)	iONE (C1238)	C2150 TERM.
POWER	GRAY	RED	GRAY	#1
POWER	GRAY	BLACK	GRAY	#4
ACT, COM	WHITE	WHITE	WHITE	#4
ACT, NO	YELLOW	GREEN	YELLOW	#2
ACT, NC	GREEN	----	GREEN	N/C
SAF, COM	WHT/STRP	BRN	----	#7
SAF, NO	YEL/STRP	BLU	----	#6
SAF, NC	GRN/STRP	----	----	N/C

EXTERIOR SENSOR

CIRCUIT DESC.	X-ZONE (C1250)	IXIO* (C1248)	iONE (C1238)	C2150 TERM.
POWER	GRAY	RED	GRAY	#1
POWER	GRAY	BLACK	GRAY	#4
ACT, COM	WHITE	WHITE	WHITE	#4
ACT, NO	YELLOW	GREEN	YELLOW	#3
ACT, NC	GREEN	----	GREEN	N/C
SAF, COM	WHT/STRP	BRN	----	#7
SAF, NO	YEL/STRP	BLU	----	#6
SAF, NC	GRN/STRP	----	----	N/C

* THE C1248 IXIO TEST OUTPUTS, VIOLET AND YELLOW, ARE NOT USED.

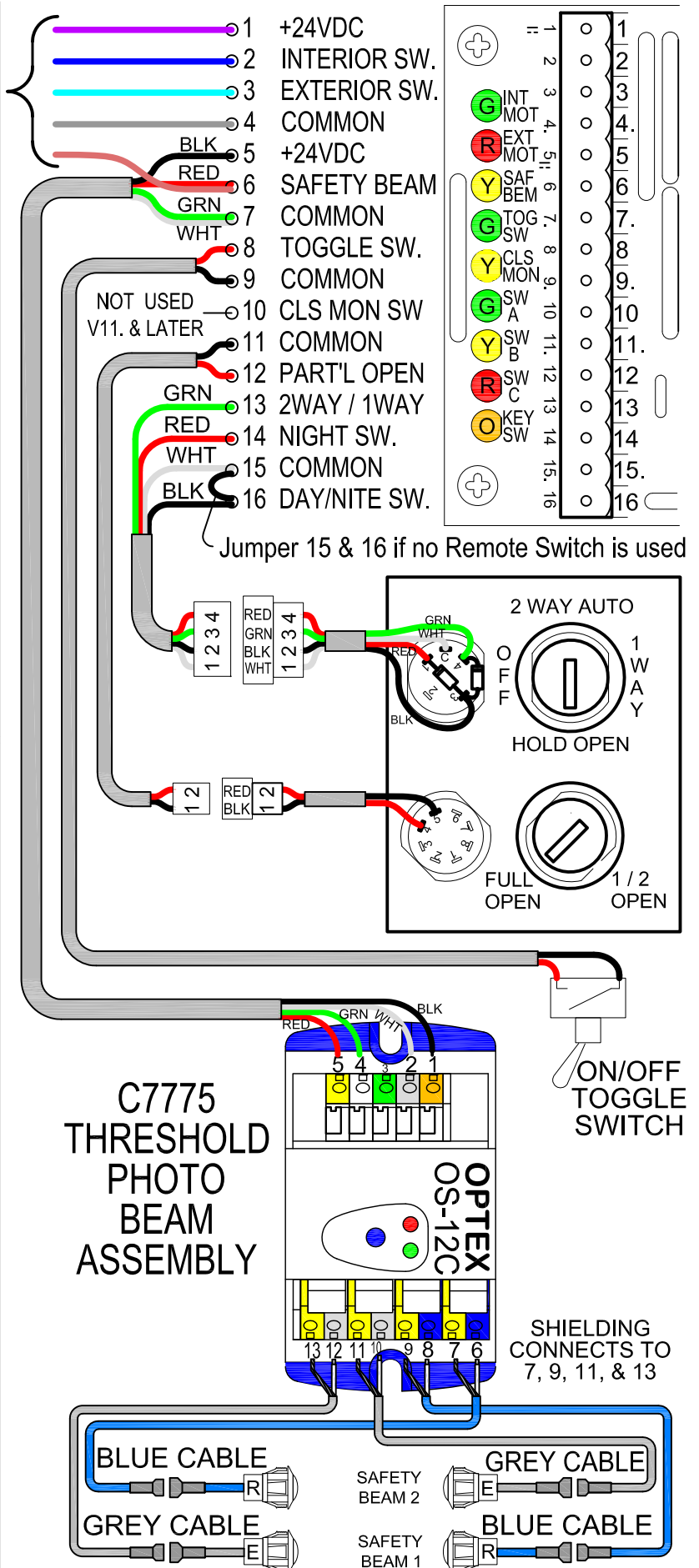
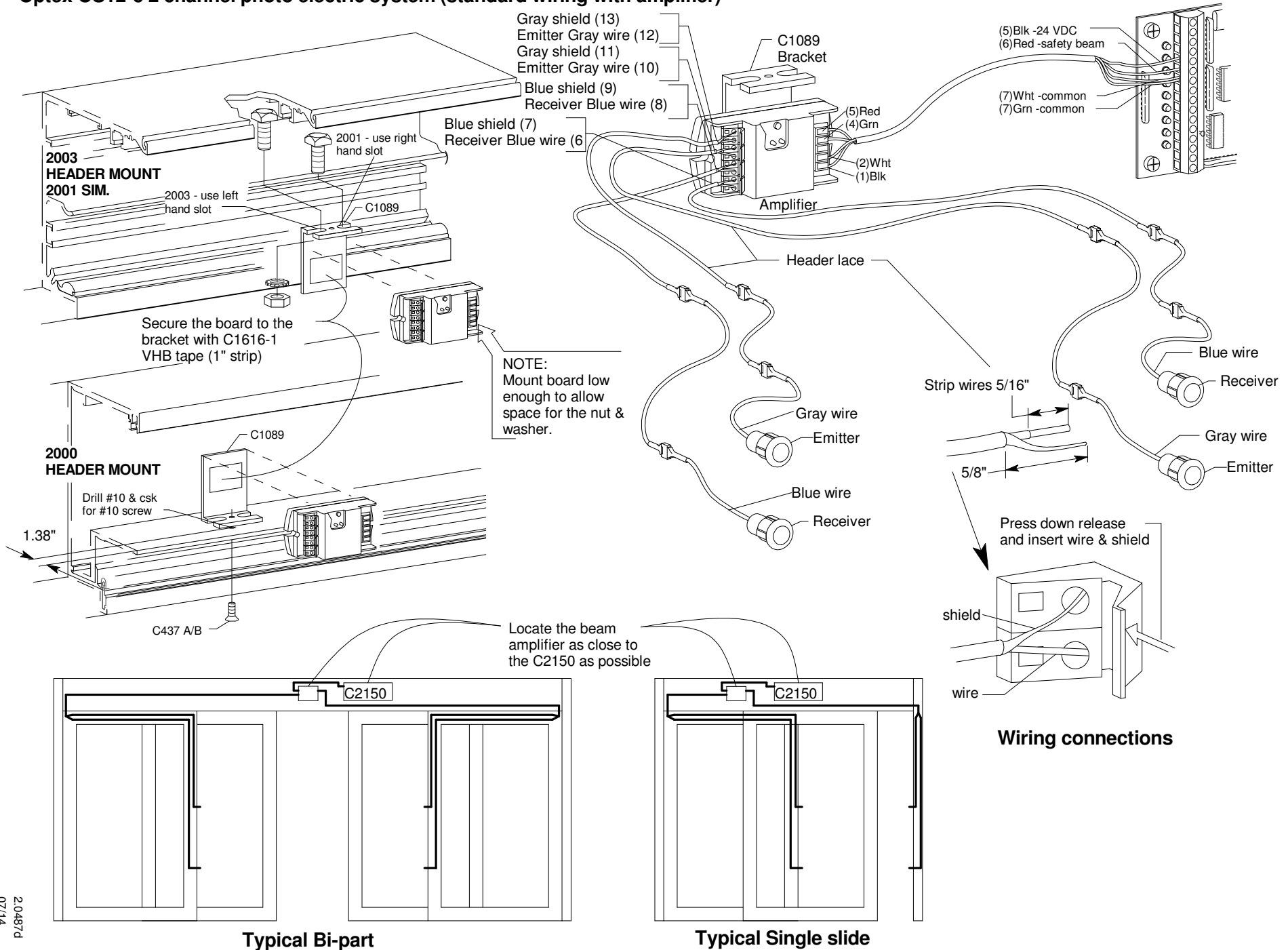

DIAGRAM 2 TYPICAL WIRING for BEAMS and SWITCHES

Optex OS12-c 2 channel photo electric system (standard wiring with amplifier)



H210.20



4242 Baldwin Boulevard
Corpus Christi,
Texas, U.S.A. 78405-3399
Tel: 800-531-3111, 361-888-5591
Fax: 800-531-3108, 361-888-6510
Internet: <http://www.hortondoors.com>

Horton Automatics, Ltd.

Unit A, Hortonwood 31
Telford, Shropshire, England TF1-4GS
Tel: 01952 670169, Fax: 0192 670181
International Tel: ++44-1952-670169
International Fax: ++44-1952-670181

A U T O M A T I C S A Division of Overhead Door Corporation, A Sanwa Shutter Company

Form H210, FEB 2016, printed in U.S.A.

Horton Automatics reserves the right to improve the product and change its specifications without notice.