

# C2150 Control

with Version 2 Software and Encoders  
for Series 2000B, 2001, 2003 & 2004  
Electric Slide Door Operators

## SETUP INSTRUCTIONS & TROUBLESHOOTING

To be used with either G2001, G230, G230T, G205, G204 or G20B  
Installation Instructions

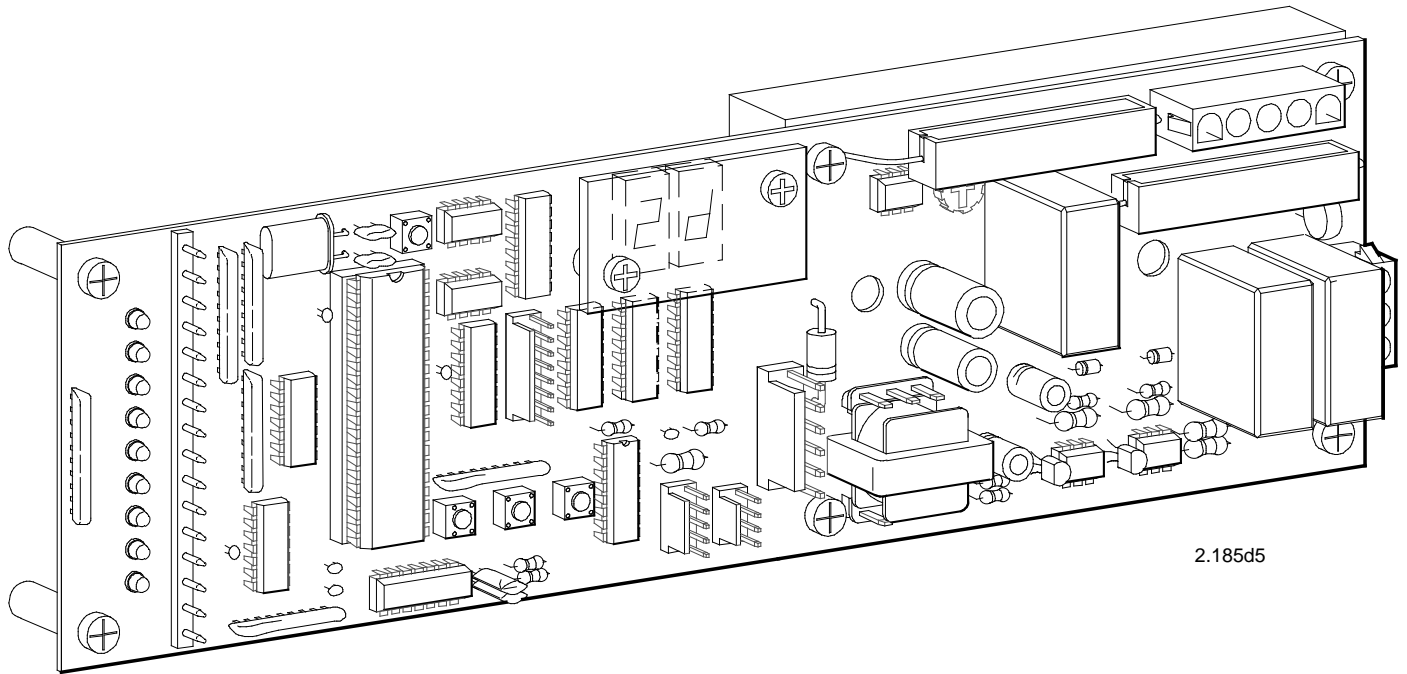

2.185d5



## CONTENTS

### SECTIONS

1. Series 2000B, 2001, 2003 & 2004 quick start instructions.....	H202.1
2. C2150 initialization (learn cycle).....	H202.2
2. C2150 initialization (learn cycle cont.).....	H202.3
3. Adjusting parameters (Procedure for changing preset parameters).....	H202.4
4. Adjustable preset parameters (chart of adjustable ranges).....	H202.4
5. Actuation features.....	H202.5
6. Autolock initialization.....	H202.5
7. Setting lock parameters.....	H202.6
8. Lock error codes (Trouble shooting guide).....	H202.6
9. Autolock test points.....	H202.6
10. Autolock functions.....	H202.6
11. Encoder error codes (Trouble shooting guide).....	H202.7
12. Encoder diagnostics.....	H202.7
13. Encoder test points.....	H202.7
14. Power failure units (Set up and testing).....	H202.8

### APPENDIX

A. In case of difficulty (Trouble shooting the C2150).....	H202.9
B1. Code displays (definitions and trouble shooting guide).....	H202.10
B2. Code displays (definitions and trouble shooting guide).....	H202.11
B3. Code displays (definitions and trouble shooting guide - short cuts).....	H202.12
C. Motor test.....	H202.13
D. Terminal CN2 (Description of terminal block connections) .....	H202.13
E. Encoder assembly (circuit board replacement).....	H202.14
F. Bracket attachment (correct attachment of power arms).....	H202.14
G. Wiring diagram list .....	H202.14

### WIRING DIAGRAMS

1. C2150 typical wiring for 2001 & 2003.....	H202.15
2. Actuating and control switch connections.....	H202.16
3. Typical wiring for beams and switches.....	H202.17

## GENERAL STATEMENT

The C2150 is a microprocessor that uses a series of inputs, outputs and custom software to control a slide door. The inputs are usually supported by LEDs that lets the technician see what information is coming into the control and the outputs are in the form of display codes, LEDs and actual control of the motor, autolocks etc. This manual is written for the C2150 control with Version 2 software which is used in the controls of 2001 and 2003 belt drive operators. The C2150 control receives its power from a separate power supply (usually a C3925) which provides +27 to +35 VDC to power all of the accessory devices as well as power for the control itself. The power supply also delivers +100 to +120 VDC to the control which is reduced by a MOSFET (duty cycle control) and is called into service at variable levels through software and parameter selection. It is our hope that this manual will guide the experienced technician through the efficient and safe setup of the C2150 slide door control. Remember that all installations must comply with ANSI 156.10.

# 1. SERIES 2001, 2003 & PROFILER-B SLIDE OPERATOR INSTRUCTIONS

C2150 Control with version 2 software (Revision E or later hardware) get the operator up and running, check the items outlined below-

Do **NOT** wire any motion detectors or any other accessories at this time. Factory pre-wired beams (pins 5,6 & 7) may be left in place.

## 1st Step

A toggle switch or jumper must be present between pins 8 & 9. Switches are sent loose and field mounted. Break-outs are wired in series with the toggle switch.

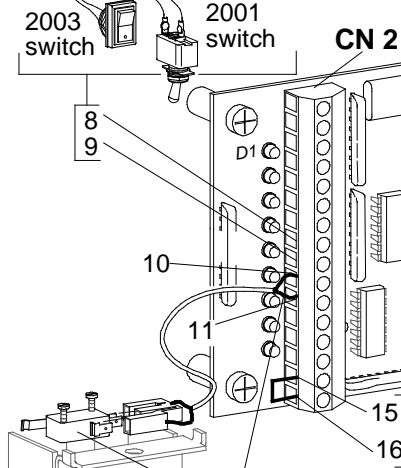

## 2nd Step

The close monitor switch must be connected to #10 & #11 of CN2. The switch must trip when the door is fully closed.

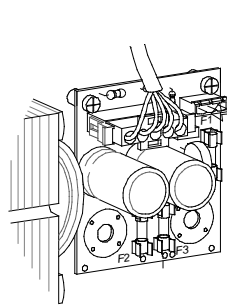

## 10th Step

Verify jumpers JB1A & JB1B are **NOT** installed on rev. E and later controls.

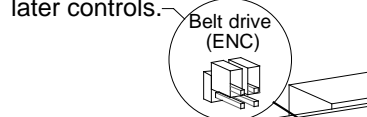

## 9th Step

Set the reversing sensitivity fully counter-clockwise.

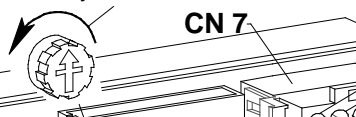

## 8th Step

Check incoming voltages from power supply

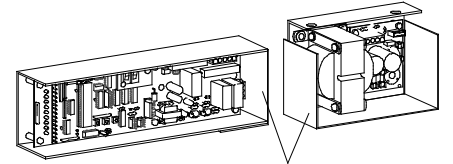

Shields and chassis are not shown in this manual for clarity

**NOTE:**  
On 2001 & 2003 Metal shields are **REQUIRED by UL** for protection against high voltage areas **Do not remove.**

## 7th Step

A 5 conductor cable attaches CN7 to the power supply.

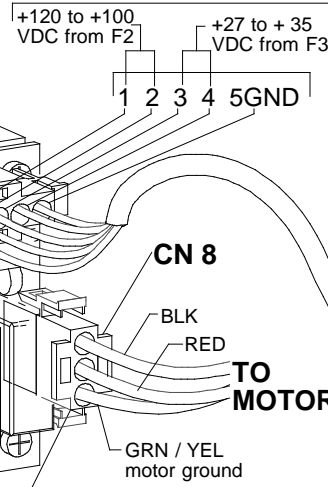

## 6th Step

Check that the incoming power is wired as shown.

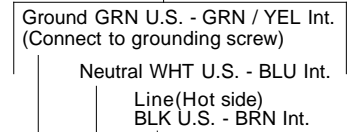

## 5th Step

The motor must be plugged into connector CN8

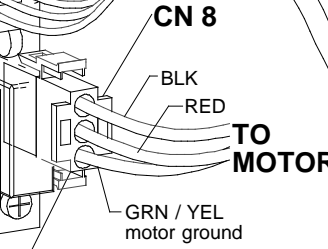

TO ENCODER

TO AUTOLOCK

## 4th Step

The encoder must be plugged into CN1 on the control.

## 3rd Step

If the day / night mode is **NOT** to be used - there **MUST** be a jumper between 15 & 16. See Sections 5 thru 10 for actuating features and lock set-up.

Field wiring options

Field wiring options

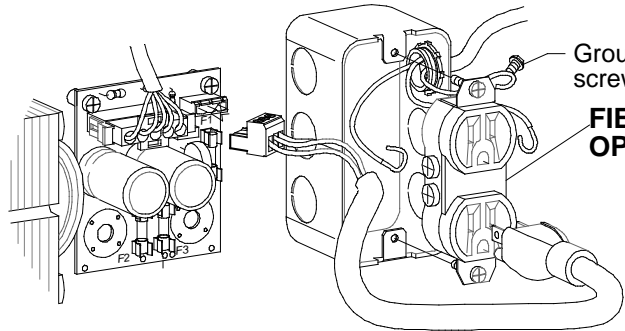

**FIELD WIRING OPTION 3**

Grounding screw

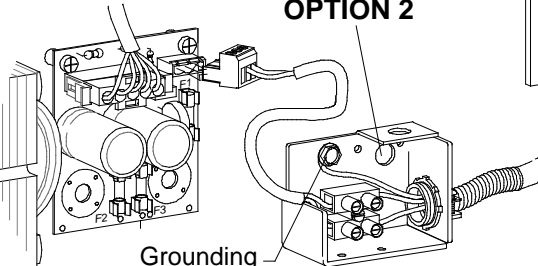

**FIELD WIRING OPTION 2**

Grounding screw

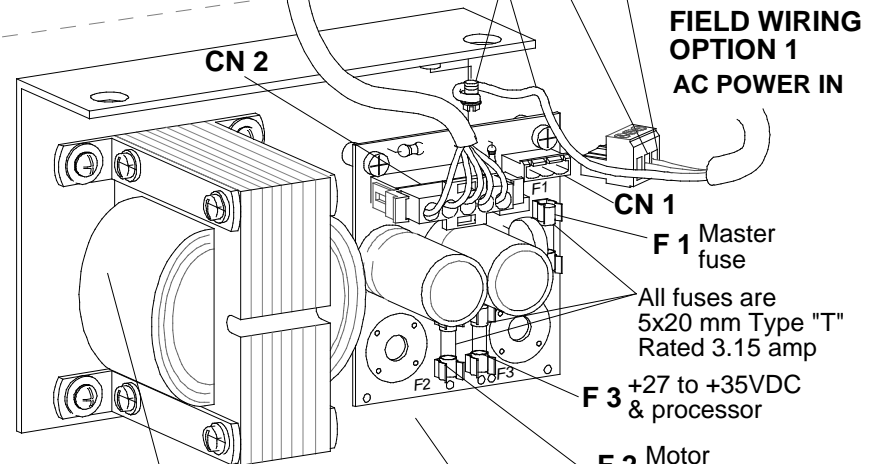

**FIELD WIRING OPTION 1 AC POWER IN**

**FN 1** Master fuse

All fuses are 5x20 mm Type "T" Rated 3.15 amp

**F 3** +27 to +35VDC & processor

**F 2** Motor +100 to +120 VDC

**POWER SUPPLY**  
C3925 for 120VAC-2001 (shown)  
C3955 for 120VAC-2003  
C3926 for 240VAC-2001  
C3956 for 240 VAC-2003

**NOTE:**  
Component arrangement may vary.

## IMPORTANT

With wiring option 1, 2 or 3 The main ground wire must be secured using the green grounding screw.

## 2. C2150 INITIALIZATION (learn cycle)

### 1st Step - Power up

Be sure the toggle circuit is complete and apply AC power to the unit.

**CAUTION: THE DOOR WILL MOVE.**

### 2nd Step - Learn cycle

Instruct the control to perform a full learn cycle by:

- Holding down the **SET** button and the **RESET** button.
- Releasing the **RESET** button.
- Holding the **SET** button for an additional 5 seconds then release.

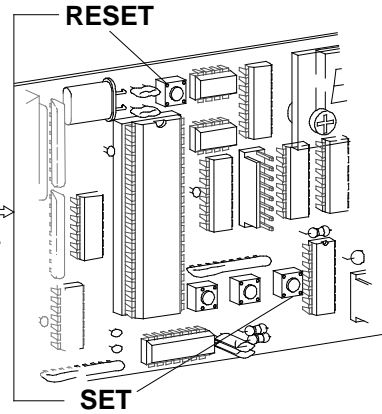

### 3rd Step - Version display

#### VERSION 2.18 and earlier

The display should "blink" the version number (as in 2 then 11) \*The display will show the lock code (see below)

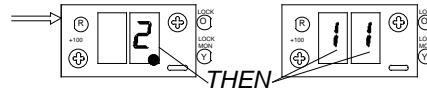

#### VERSION 2.19 and LATER

In version 2.19 and later, the display will show **SU**

- If **SU** does not appear, then the control was not properly reset into the full learn mode (Go back to step 2)
- The display should "blink" the version number (as in 2 then 19)

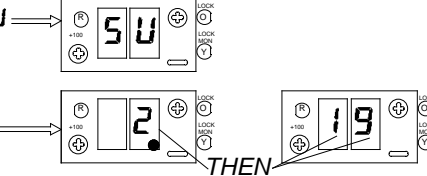

- If the display flashes **nA** like an error code, The **nA** (no Access) parameter has been turned on.



- A full learn cycle can not be completed with this security parameter in place. Consult your supervisor or the factory for authorization and instructions on how to remove this security parameter.

### \*LOCK CODES

- The control will display **ONE** of the following lock codes depending the type of lock connected. (see Section 6)

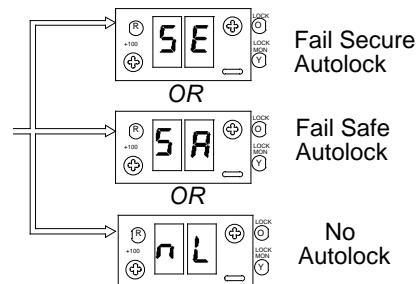

### 4th Step - Setting series type NOTE: for versions earlier than 2.15 go to Step 5.

#### FOR VERSION 2.15 - 2.18

- The display will flash alternately **tY** and **?**, indicating the control is ready to be set to the proper series operator.



- Press the **UP** button for 2001

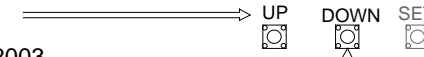

- Press the **DOWN** button for 2003

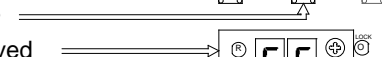

- Hold the button until **FC** is displayed



#### FOR VERSION 2.19 or later

- The display will flash **tY** and then **1**. This is the menu that selects the series type.

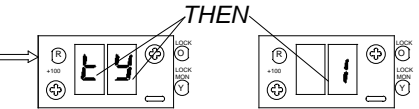

- Use the **UP & DOWN** buttons to locate the series number of the unit.



- Select **1** for 2001 (0 will default to 2001)



- Select **2** for 2003 (C5600 motor)



- Select **3** for 2003 (C5600-1 motor)

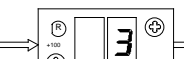

- To approve the selected type push the **SET** button

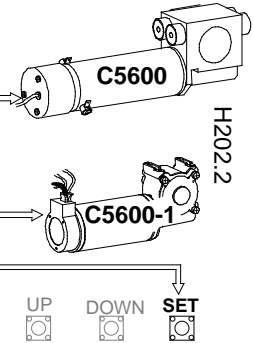

- NOTE: Pressing the wrong button (wrong series) will result in the operator proceeding in a setup which should yield proper operation, but the number displayed when accessing **E5** (total stroke) and other stroke dependent parameters will be incorrect.



### 5th Step - Close stop

- The display should indicate **FC** (for first run - Finding Close stop) The door should fully close at slow speed.

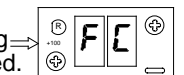

- If the door moves a short distance then stops, and the display indicates **Pd**, the pre-wired safety beams or other actuating devices are stopping the door and preventing the "learn cycle". The yellow **SAF BEM** indicator will be lit.

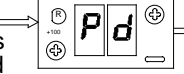

- In versions later than 2.11, **Pd** can be overcome by holding the up button until the door closes.



- The yellow **CLS MON** (close monitor) indicator will come on when the door is fully closed.



## 2. C2150 INITIALIZATION (learn cycle cont.)

### 6th Step - Finding Open

•The display will show **FO**(Finding Open). The door will travel slowly open until it reaches full stroke. The stroke will be displayed in inches.

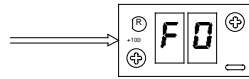

•**±5** is displayed indicating Total Stroke.

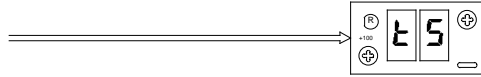

•If the stroke on the display is not the same as the actual stroke of the door, the wrong series type may have been selected.

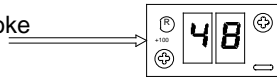

### 7th Step - Day mode

In versions prior to 2.19...

•The display will switch to **dA** (dAyttime mode).

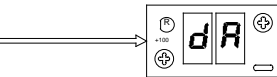

In versions 2.19 or later...

•The display **2d** (2-way daytime mode).



•If the display switches to something besides (dA or 2d) and the door refuses to do anything else....

**CHECK**

- The green TOG SW indicator on the control should be on.
- The toggle switch should be turned on.(between 8 & 9 on CN2)
- If there are SO panels, be sure the magnetic reed switches on the breakouts are closed.

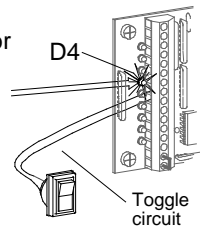

**IF ANY OF THE CODES DEVIATE FROM THOSE SHOWN SEE APPENDIX B**

### 8th Step -Checking door cycle

When the toggle switch is on, the **DOWN** button acts as an actuation device. **The door will move** - Be sure the safety beam area is clear of obstructions. Activation devices should not yet be installed.

Start with the door in the closed position. Press the **DOWN** button to actuate the door to open at factory selected default settings.

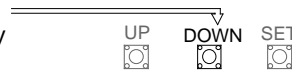

The chart at the right shows the position of the door and the display code for each position.

Inspect the unit for smooth operation, free of binds and excessive noise.

The following cycles are carried out automatically by the C2150 control

•The display starts with:

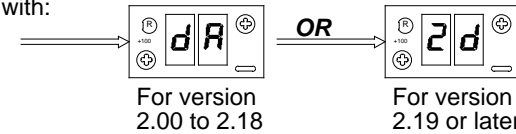

### Open Cycle

•Open Speed

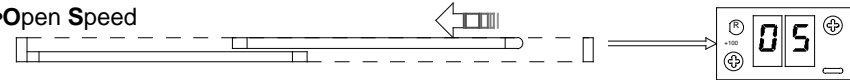

•Motor Braking

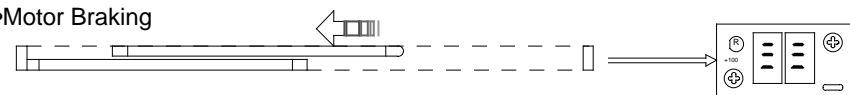

•Open Check \*

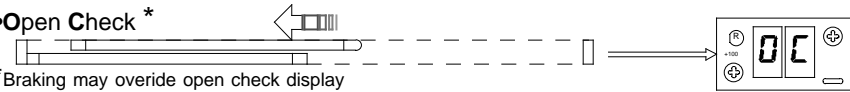

\*Braking may override open check display

•Open cUshion

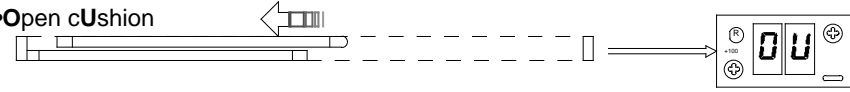

•Time Delay

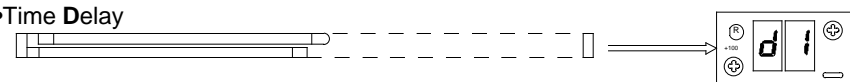

### Close Cycle

•Close Speed

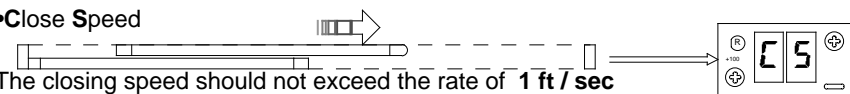

The closing speed should not exceed the rate of **1 ft / sec**

•Close Check



•Close cUshion

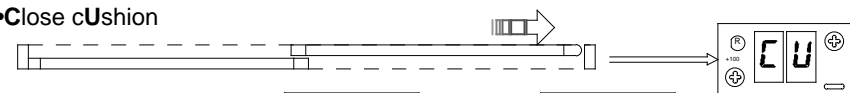

•The display returns to:

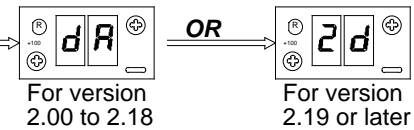

•If the above cycle check is OK and there are no parameters to be changed or an autolock to setup, this concludes the C2150 initialization.

**IF THERE IS ANY DIFFICULTY SEE APPENDIX A**

### 3. ADJUSTING PARAMETERS

#### 9th Step - Changing parameter settings

A chart of preset values is shown to the right.

If any speeds or other settings need to be changed, follow this procedure:

- Turn the toggle switch **OFF**

Or for versions 2.12 and up, leave the toggle **ON** and double click the **SET** button.

- The display will switch to the menu of adjustable parameters

- In versions 2.10 and up, the right decimal point will be blinking

- Refer to the chart in section 4 for a list of codes for adjustable parameters.

- Scroll through the parameter list using the **UP** and **DOWN** buttons until the parameter to be changed is found.

- When the parameter to be changed is found, press and hold the **SET** button.

- The display will show the current value or setting of the parameter.

- While holding the **SET** button, press the **UP** or **DOWN** button to modify the setting.

- When the **SET** button is released, the display will show the parameter that was just changed. Another parameter may be changed, or the toggle circuit turned on to check the changes just made. In versions 2.12 and up the **SET** button may be double clicked to exit the menu (toggle must be on).

#### 10th Step - Saving new settings

- When all adjustments have been made and checked, be sure the toggle circuit is on.

- With the display reading **d1** or **d2** press and **HOLD** the **SET** button until **d5** (data save) is displayed. All of the changes are now stored in the control's memory. **This step must be performed** or the control will revert to the default settings after a power failure.

- Set the reversing sensitivity as required using R10. **Do not** leave this adjustment at minimum. Horton recommends setting the sensitivity so the door will **reverse at 28 ft.lb.** or less.

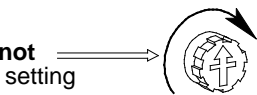
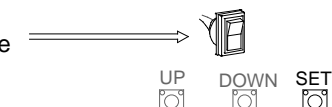
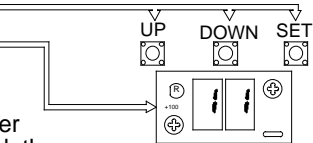
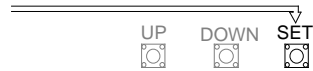
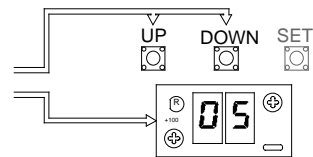
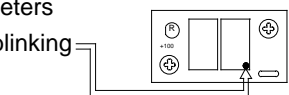
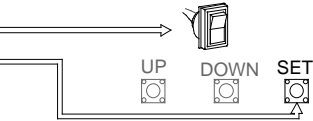

### 4. ADJUSTABLE PRESET PARAMETERS

The chart below shows all the adjustable parameters for **version 2 software**.

Follow the procedure outlined in step 9 to make any necessary changes.

CODE	PARAMETER	FACTORY PRESET VALUE	ADJUSTS
<b>OS</b>	Open Speed	10	0-15
<b>CS</b>	Close Speed	12*	0-15
<b>OC</b>	Open Check	4	0-15
<b>CC</b>	CloseCheck	4	0-15
<b>OU</b>	Open cUshion	3	0-15
<b>CU</b>	Close cUshion	3	0-15
<b>d1</b>	delay time 1 (full open)	1 sec	1-60**
<b>d2</b>	delay time 2 (partial open)	1 sec	1-60**
<b>RC</b>		1 (factory set - do not change)	
<b>HD</b>		3 (factory set - do not change)	
<b>rC</b>		3 (factory set - do not change)	
<b>CP</b>	open Check Point	75% of stroke	50-90% <b>ts</b>
<b>PO</b>	Partial Open position	8" (adjustable in inches)	8"- <b>ts</b>
<b>tS</b>	total Stroke	(as determined by learn cycle)	12-199"
<b>ct</b>	cycle test	oF (no)	oF/on
<b>AS</b>	Auto Seal	oF (no)	oF/on
<b>St</b>	Stop OKon first run	on (yes)	oF/on
<b>Hd</b>	Heavy-duty door/motor	oF (no)	oF/on
<b>PF</b>	Power Fail	OP (power fail OPen)	OP/CL
<b>Pn</b>	Power fail Night mode	on (version 2.13 & up only)	oF/on
<b>Cb</b>	Close braking	oF (on)(Version 2.03 & up only)	oF/on
<b>br</b>	brake on recycles	oF (on)(Version 2.03 & up only)	oF/on
<b>LL</b>	Lock present	oF (on if Horton lock is present)	oF/on
<b>SR</b>	fail-SAFe lock	oF(fail-secure) (on fail-safe)	oF/on
<b>UL</b>	Unmonitored Lock	oF (monitored lock)	oF/on
<b>bL</b>	Bistable Lock	oF (Never used)	oF/on
<b>dL</b>	daytime Lock	oF(if lock stays unlocked in day mode)	oF/on
<b>L1</b>	daytime 1-way Lock	oF (version 2.03 & up only)	oF/on
<b>RP</b>	APex	oF	oF/on
<b>SL</b>	SLOw	oF (All open speeds)	oF/on
<b>J5</b>	Jam Sensing	on (version 2.07 & up only)	oF/on
<b>rP</b>	reverse on encoder Pulse	on (version 2.06 and up only)	oF/on
<b>SP</b>	Sidelite Protection	oF (version 2.03 and up only)	oF/on
<b>nR</b>	no Adjustment permitted	oF (version 2.05 and up only)	oF/on
<b>tY</b>	TYpe	1 (Set during initialization)	1-2-3
<b>Ob</b>	OBstruction	3 (factory set - most sensitive - 0 off)	0-3

\***Caution:** very light doors may require a lower speed setting

\*\*In versions 2.06 & prior, **d1** and **d2** adjust from 1-199 seconds.

\*\*Beginning with version 2.07, these parameters may be set to 1-8, 10, 12,14, 16, 20, 25, 30 or 60 seconds.

•A double dash (-) is a reserved parameter that is not implemented.

## 5. ACTUATION FEATURES

Set jumpers or key switch for the type of operation required. See diagram 2 page H202.16

**2-way day mode factory setting is:** jumper or switch from 15 to 16.

**1-way day mode setting is:** jumper or switch from 13 to 15 and 15 to 16.

**2-way night mode setting is:** **NO** jumpers or switches

**1-way night mode setting is:** jumper or switch from 13 to 15 **NO** jumper or switch from 15 to 16

### NOTE:

Many other features, for autolock and motion detector configuration, are available through additional adjustable parameters. These parameters can be discussed in greater detail by calling the technical service group.

CODE DISPLAY

RESET

LOCK (Orange)

LOCK MON (Yellow)

SET

Double click = off or on  
Press and hold = data save

Connect to CN 4

UP DOWN Display Scroll

Com 15  
16

13  
15  
16

13  
15  
16

13  
15

These displays apply to 2.19 and up only

TS 2

TS 1

**FAIL SECURE**  
Remains locked at power failure

Lock monitor SW

TS 1

TS 2

**FAIL SAFE**  
Unlocks at power failure

Lock monitor SW

**1st Step**  
Set jumpers as shown for fail secure or fail safe

Fail safe

Fail secure

## 6. AUTOLOCK SET UP AND INITIALIZATION

Press **SET** and **RESET** simultaneously, release **RESET**, wait 5 seconds, then release **SET** - version number will displayed. During initialization the control clears all ports and the solenoid becomes inactive.

### FAIL SECURE

The C2150 looks to see if there is a contact at the lock port CN4 and if the yellow lock monitor LED is off.

If the yellow LED is off...

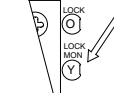

The control sends a pulse to retract the solenoid...

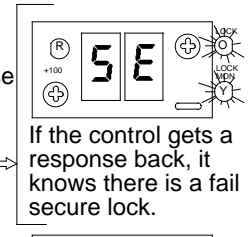
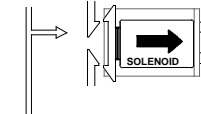

If the control gets a response back, it knows there is a fail secure lock.

If there is no response it knows there is no lock.

### FAIL SAFE

The C2150 looks to see if there is a contact at the lock port CN4 and if the yellow lock monitor LED is on.

If the yellow LED is on...

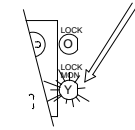

The control sends a pulse to retract solenoid...

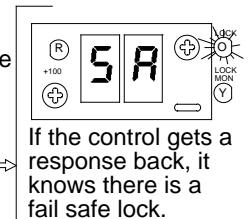
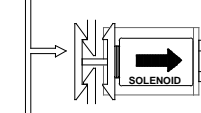

If the control gets a response back, it knows there is a fail safe lock.

If there is no response it knows there is no lock.

## 7. SETTING LOCK PARAMETERS

To set up the lock parameters on the C2150 turn off the toggle circuit or double click the **SET** button. Use the **UP / DOWN** buttons to locate **dL & L1**. Press the set button to display the on or off setting. Set **dL / L1** as required from the table below.

Traffic Mode		dL:of	dL:of	dL:on
SEE SECTION 5		L:of	L:on	doesn't matter
Day	2-Way	Unlocked	Unlocked	Locked
Day	1-Way	Unlocked	Locked	Locked
Nite	2-Way	Locked	Locked	Locked
Nite	1-Way	Locked	Locked	Locked

SEE SECTION 3 STEP 10 FOR ( d5 ) DATA SAVE PROCEDURE

## 8. LOCK ERROR CODES

<b>LF</b>	<b>Lock Failure (Fail Secure)</b> Indicates that the lock monitor input is remaining active (lock monitor light is still on) even though solenoid has de-energized.
<b>UF</b>	<b>Unlock Failure (Fail Secure)</b> Indicates that the lock solenoid failed to move the plunger enough to activate the lock monitor switch and notify the control that the door is ready to be opened.
Check for mechanical binding. Check items under AUTOLOCK TEST POINTS and AUTOLOCK FUNCTIONS FOR FAIL SECURE autolocks.	
<b>LF</b>	<b>Lock Failure (Fail Safe)</b> Indicates that the lock solenoid failed to move the plunger enough to activate the lock monitor switch.
<b>UF</b>	<b>Unlock Failure (Fail Safe)</b> Indicates that the lock solenoid spring has failed to move the plunger enough to activate the lock monitor switch and notify the control that the door is ready to be opened.
Check for mechanical binding. Check items under AUTOLOCK TEST POINTS and AUTOLOCK FUNCTIONS FOR FAIL SAFE autolocks.	

## 9. AUTOLOCK TEST POINTS

Basic voltage readings regardless of type. Set VOM at 200VDC.

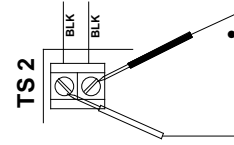
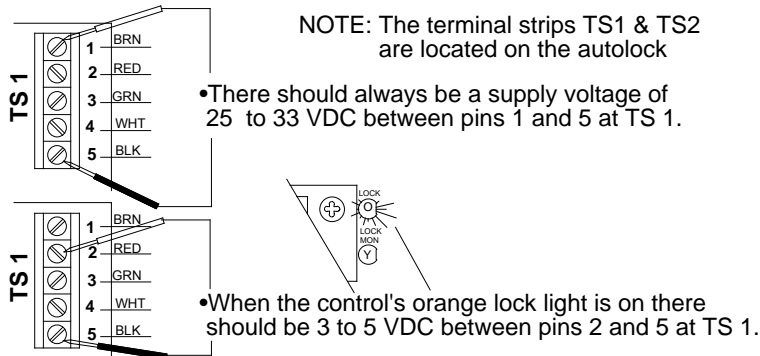

•When the solenoid initially energizes there should be 25 to 33 VDC at TS2. After about a second the voltage will drop to about 30% of the supply voltage between pins 1 and 2 of TS2 .

## 10. AUTOLOCK FUNCTIONS

The **FAIL SECURE** is the most common type of auto lock used with the C2150.

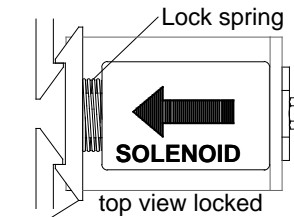

When power is removed, the solenoid is extended by the lock spring. The door is locked.

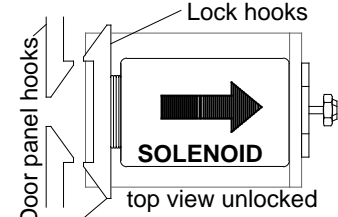
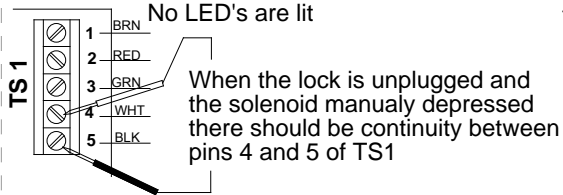

When power is applied the solenoid is retracted and the door is unlocked.

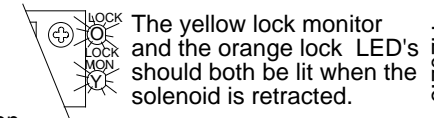

H2026

The **FAIL SAFE** is a less common type of auto lock used with the C2150.

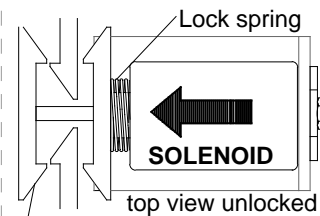

When power is removed the solenoid is extended by the lock spring. The door is unlocked.

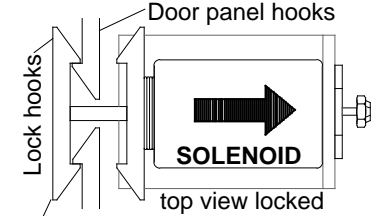
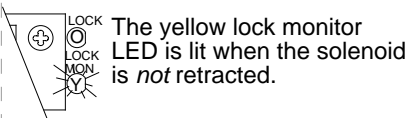

When power is applied the solenoid is retracted and the door is locked.

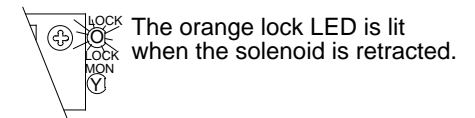

When the lock is unplugged and the solenoid is *not* manually depressed there should be continuity between pins 4 and 5 of TS1. Check the jumpers on the Autolock circuit board. (see section 6)



## 11. ENCODER ERROR CODES

Encoder error codes are displayed when the door is running. Normally codes will be displayed at the end of a stroke or when a door stops abruptly during an "open" command.

### Types of failure codes that could be displayed:

- EF** Encoder Failure - No pulses being received by the C2150.
  - Check all connections to encoder and the control.
- LP** Loss of Pulses - All pulses required for proper operation were not received.
  - See encoder test points Section 13
- EP** Encoder Phasing - Encoder indicates door is moving opposite direction it should be.
  - Power brackets are connected to the belt backwards (see appendix F)
  - Wires should be reversed at terminal 2 & 3 on the encoder on C5600 & C3675 only.
- E $\bar{E}$**  Encoder Test - The beginning of an encoder test procedure.
  - See section below

## 12. ENCODER DIAGNOSTICS

Encoder information is needed to provide consistent information on location, direction of travel, speed of door and door braking information to the C2150 control.

### 1st Step - Encoder test

- Press **RESET** and the **DOWN** button together
- Release **RESET** and continue to hold the **DOWN** button until **E $\bar{E}$**  briefly appears - release the **DOWN** button. Following **E $\bar{E}$**  2 short lines will appear. The test is ready to be performed.

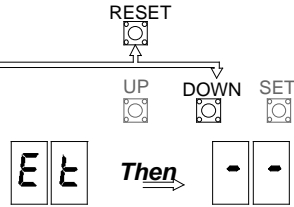

### 2nd Step - Performing test

View the display while manually moving the door **slowly** towards the open position. The display will show a counter clockwise rotation.

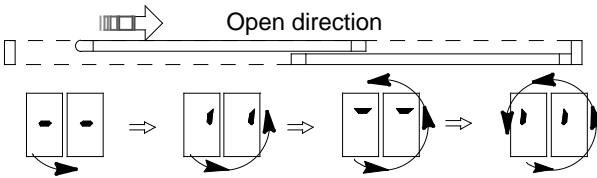

Manually move the door towards the closed position. The display will show a clockwise rotation.

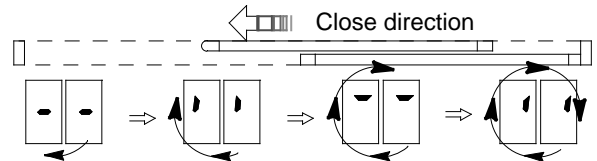

Each segment of 4 for a total of 8 segments should appear. No segment should be skipped. If anything occurs other than the description shown above the C2150 will get improper information and the door will not function properly.

## 13. ENCODER TEST POINTS

To test the encoder you will need a volt ohm meter (**VOM**) capable of reading DC Voltage.

### Checking power and pulses

- Turn the toggle circuit off.

- Set the **VOM** to **200 DCV**

- Probe through the back of the red plug leaving it attached to CN 1.

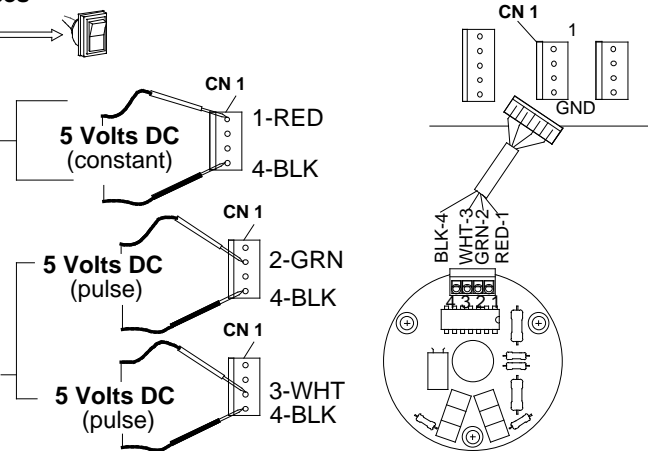

- To verify the encoder is producing pulses slowly move the door manually with the meter attached to 2 & 4 then 3 & 4. Watch the meter for 5 volt pulses.

If the above voltages check out and the display does not rotate as shown in section 12 then contact the technical services group.

### Checking connections

- Check JB 1. This circuit should be open - jumpers off as shown.
- Confirm that the encoder is plugged into CN1 and that the wires are connected to the plug.

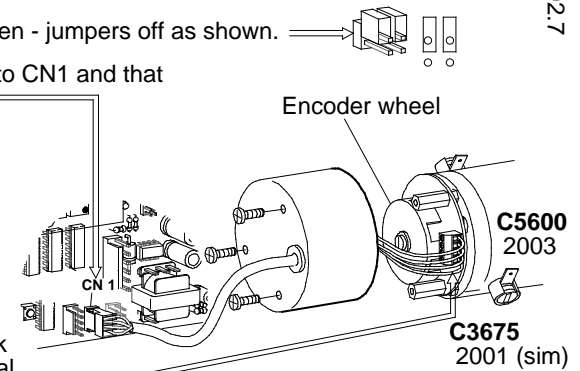

### Power but no pulse

There is power between pins 1 & 4 but there is no pulse between 2 & 4 or 3 & 4.

### On the C5600 & C3675 only

- Remove the encoder cover and check that all wiring is secured in the terminal block.
- Check the rotation of the encoder wheel as the door is moved manually.
- Check the depth of the encoder wheel as it passes through the encoder optics.
- If all visual inspections pass, the encoder board may have failed. Remove and replace. **See appendix E**

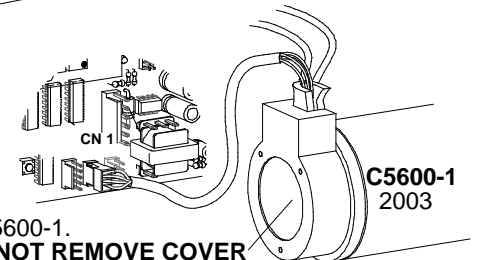

There are **no serviceable elements** on the C5600-1. If the encoder fails replace the entire unit. **DO NOT REMOVE COVER**

## 14. POWER FAILURE UNITS

The function of a power failure unit is to open or close the door (as selected) in the event of a power failure.

### 1st Step

Mount the unit to the header slots with square bolts provided.

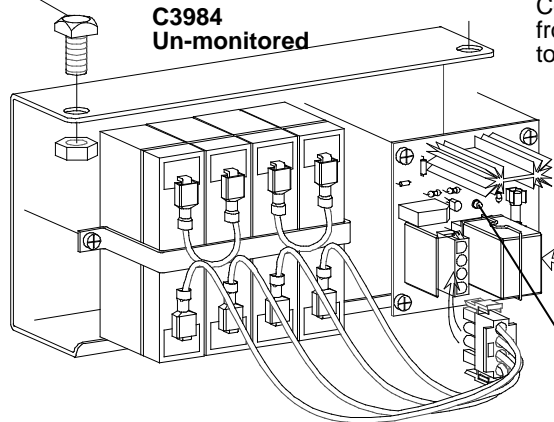

**C3984  
Un-monitored**

### 2nd Step

Connect the C3989 wiring harness from CN1 on the power fail unit to CN3 on the C2150

RED LED  
Charge indicator

### 4th Step

Go to the **PF** parameter in the C2150 (see section 4)

- Set to **DP** for the door to **open** when the power fails.
- Set to **CL** for the door to **close** when the power fails.
- To inhibit the power failure feature at night, go to the **Pn** parameter and turn it off.

The batteries could take up to 10 hours to charge before they can be tested.

### 3rd Step

Connect C3889 jumper from J1 on the C2150 to J1 on the power supply.

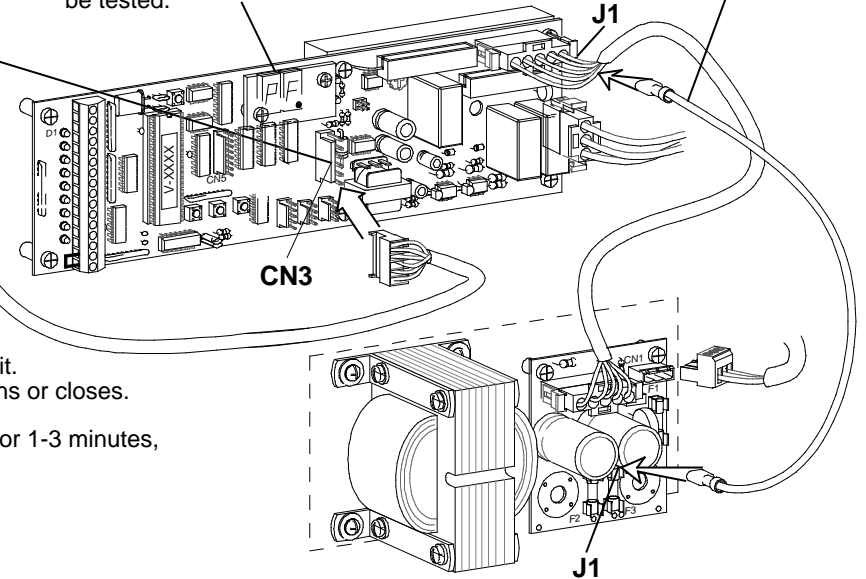

CN3

J1

H202.8

### Testing the un-monitored power fail unit

- Unplug the power at CN1 on the power supply, or turn off the breaker supplying power to the unit.
- The C2150 display should switch to **PF** within one second, and then to **CL** or **DP** as the door opens or closes.
- With the door full open or closed, the entire control should go dead until power is restored.
- When power is restored, the red charge indicator on the circuit board should come on and glow for 1-3 minutes, then dim and go completely out if the batteries were fully charged when the test began.

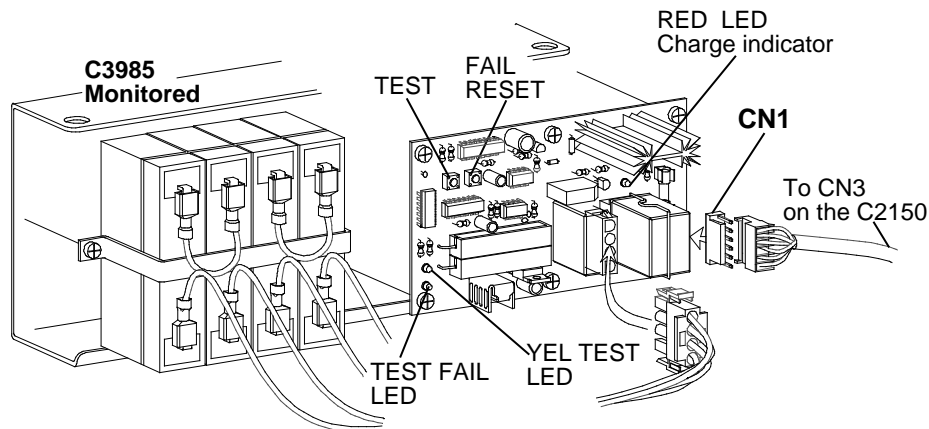

**C3985  
Monitored**

RED LED  
Charge indicator

CN1

To CN3  
on the C2150

TEST

FAIL  
RESET

TEST FAIL  
LED

YEL TEST  
LED

### Monitored power fail unit

This unit automatically tests its batteries at startup and at least once an hour afterwards.

- If the batteries test fails during daytime operation it will go to full open position (as per European standard) and stay open. The C2150 display will flash bF until the failure is corrected.
- To maintain security, battery failures are ignored in the night mode, but the failure is stored on the units circuit board. When the door is switched to the day mode it will open fully and indicate the failure on the C2150 display.

### Manual test

- Press and hold the test button on the circuit board until the yellow LED test indicator comes on, then release it. The pack is now self testing to insure that enough power is available to open or close the door for one cycle. If the test is OK the indicator will go out in about 15 seconds and the red charge indicator will come on. It will glow for about 5-7 minutes, then dim and go out. (Assuming the batteries were fully charged when the test was started).

## APPENDIX A IN CASE OF DIFFICULTY

### 1.If DISPLAY FAILS TO LIGHT

- Go to section 1 step 8 and check for DC voltages shown on CN7 terminals 3&4.
- If voltage is **not present**, check AC power at pins 1&2 of CN1 of power supply.
- If AC power is **present**, check fuses F1 & F3 of the power supply.

### 2.If DISPLAY LIGHTS, BUT DOOR NEVER MOVES

- Go to section 1 step 8 and check for DC voltages shown on CN7 terminals 1&2.
- If voltage is **not present**, check fuse F2 of the power supply.
- If F2 is good power supply is faulty.
- If voltage is **present** on CN7 and display is showing a run code ie: **OS, OU, [S, [I** or **[U** check for motor voltage (with motor plugged in) on pins 1 and 2 of CN8 leaving the control. Use 200 VDC scale.
- If voltage is **not present** at CN8, change control.
- If voltage is **present** at CN8, go to appendix C for motor test.

### 3.DOOR SLAMS OPEN and / or CLOSED WITH NO SPEED CONTROL

- Go to appendix C for motor test ( to make sure motor did not ruin control)
- If motor test good, change control.

### 4.DISPLAY WILL ONLY SHOW OS

- Make sure toggle circuit is complete by turning toggle switch off and on. The green TSW LED should go off and come back on. This LED must be on for the door to operate.

### 5.ERROR CODE OR SOME OTHER ABNORMAL DISPLAY APPEARS.

- Go to appendix B - find the code and follow the instructions.

### 6.FUSE F2 BLOWS REPEATEDLY

**CAUTION:** disconnect the power supply at CN1 and wait 30 seconds before servicing.

- Unplug the power harness at CN7 (section 1 step 8) and the motor at CN8 and replace the fuse (slow blow 5 x 20mm Buss type GDC 3.15 or equal )
- If the fuse blows again, replace the power supply.
- If the fuse does not blow, reconnect the power harness at CN7 and attempt to operate the door with the motor unplugged.
- If the fuse blows now, replace the C2150 control (first check motor as shown in appendix C).
- If the fuse does not blow, plug the motor in and try again.
- If the fuse blows again and the motor checked good, check for a mechanical bind. Check **br** and **JS** parameters in appendix A which can help prevent fuse blowing.
- Consult Technical Assistance at the Horton factory.

### 7.FUSE F3 BLOWS REPEATEDLY

**CAUTION:** disconnect the power supply at CN1 and wait 30 seconds before servicing.

- Unplug the power harness at CN7 (section 1 step 8) and all connections of pins 1 and 5 of CN2 and CN4 autolock, if present, and replace fuse F3 again (slow blow 5 x 20mm Buss type GDC 3.15 or equal )
- If the fuse blows again, replace the power supply.
- If the fuse does not blow, reconnect the power harness to CN7.
- If the fuse blows now replace the C2150 control.
- If the fuse does not blow replace the autolock, and connections at pins 1 and 5 of CN2 one at a time until F3 blows indicating a short circuit in that component or its wiring. Beams and their wiring are the most frequent cause of F3 failure.

**APPENDIX B1 CODE DISPLAYS** Codes are arranged in alphanumeric order (NOTE: D = Display, P = Parameter, E = Error)

CODE	DISPLAY MEANING	TYPE	VERSION
≡≡	Control is braking - door always brakes when opening. Close braking can be turned on at the <b>Ⓛb</b> parameter	D	2.00 △
<b>BB</b>	Control has failed - must be replaced	E	2.00
<b>1d</b>	Door is idle in <b>1</b> way <b>d</b> ay mode. See section 5	D	2.19
<b>1n</b>	Door is idle in <b>1</b> way <b>n</b> ight mode. See section 5	D	2.19
<b>2d</b>	Door is idle in <b>2</b> way <b>d</b> ay mode. See section 5	D	2.19
<b>2n</b>	Door is idle in <b>2</b> way <b>n</b> ight mode. See section 5	D	2.19
<b>RR</b>	Door was activated or is being held open by SW 'C' input. See App. D CN2 for wiring & LED	D	2.15
<b>RL</b>	This parameter is factory set - do not change without consulting factory	P	2.00
<b>Rd</b>	Use only with APEX system - see APEX instruction G550	P	2.18
<b>R1</b>	Use only with APEX system - see APEX instruction G550	P	2.18
<b>RP</b>	To activate this APEX feature you must - turn the parameter on - do a data save, and then press reset only	P	2.18
<b>RS</b>	When <b>Auto Seal</b> parameter is turned on, the display will change to <b>RS</b> and the control will try to close the door every 15 seconds	PD	2.00
<b>RU</b>	Use only with APEX system - see APEX instruction G550	P	2.19
<b>bF</b>	This indicates battery failure of C3985 monitored power failure unit - see section 14	E	
<b>b1</b>	Use only with APEX system - see APEX instruction G550	P	2.18
<b>bL</b>	<b>bi</b> stable <b>L</b> ock - no longer used	P	2.00
<b>br</b>	<b>B</b> rake on recycle turned on, the control will slow door substantially before reversing on recycle	P	2.03
<b>Ⓛb</b>	When <b>close braking</b> parameter is turned on, the control brakes the door after close speed - recommended for heavy doors	P	2.03
<b>ⓁC</b>	<b>C</b> lose <b>C</b> heck speed - see section 2, step 8	PD	2.00
<b>Ⓛd</b>	Use only with APEX system - see APEX instruction G550	D	2.19
<b>ⓁE</b>	APEX communication error - if using APEX then turn AP on	D	2.18
<b>ⓁL</b>	Power fail <b>C</b> lose see section14	D	2.11
<b>ⓁP</b>	This parameter determines stroke to open check. Adjustable from 50-90% of total stroke	P	2.00
<b>ⓁS</b>	<b>C</b> lose <b>S</b> peed see section 2 step 8	PD	2.00
<b>Ⓛt</b>	<b>C</b> ycle <b>t</b> est will cause door to open and close repeatedly for test purposes	PD	
<b>ⓁU</b>	<b>C</b> lose <b>C</b> ushion speed (see section 2 step 8)	PD	2.00
<b>d1</b>	Main time delay- starts when all activate and recycle inputs clear and door is fully open	PD	2.00
<b>d2</b>	Partial open delay is active when SW 'A' is on (App. D) & starts when all activate and recycle inputs have cleared & door is at partial open	PD	
<b>dR</b>	Door idle in <b>dA</b> y mode.(Has been replaced in later software by <b>1d</b> or <b>2d</b> parameter see section 5	D	2.00 / 17
<b>dF</b>	Control failed to store parameters (control must be replaced)	E	2.00
<b>dL</b>	<b>D</b> oor <b>L</b> ocks (in day mode ) when this parameter is turned on. See section 7	P	2.00
<b>dn</b>	This is a cycle code (see foot note ) from <b>D</b> OWN button	D	2.15
<b>dS</b>	This shows a successful Data Save. See section 3 step 10	D	
<b>ER</b>	This is a cycle code (see foot note ) from ext motec input see appendix D CN2	D	2.15
<b>EF</b>	<b>E</b> ncoder <b>F</b> ailure see section11	E	2.00
<b>EP</b>	<b>E</b> ncoder <b>P</b> hasing error see section 11	E	2.02
<b>Er</b>	Use only with APEX system - see APEX instruction G550	DP	2.18
<b>Et</b>	Brief display indicates start of <b>E</b> ncoder <b>t</b> est see section 11	D	2.00
<b>EU</b>	Use only with APEX system - see APEX instruction G550	D	2.18

H202.10

## APPENDIX B2 CODE DISPLAYS

CODE	DISPLAY MEANING	TYPE	VERSION
<b>FC</b>	<b>F</b> inding <b>C</b> lose is displayed when the door is closing to the fully closed position after a power failure or during learn initialization cycle see sect. 2 step 5	D	2.00 ↕
<b>FO</b>	<b>F</b> inding <b>O</b> pen is displayed when the door is opening while counting encoder pulses. See section 2 step 6	D	2.00 ↕
<b>Hd</b>	This parameter should be turned on when using a 1/4 HP motor and a light door. (Reduces abruptness of closing )	D	2.00 ↕
<b>hh</b>	Use only with APEX system - see APEX instruction G550	P	2.18
<b>h f</b>	Use only with APEX system - see APEX instruction G550	P	2.18
<b>HL</b>	Use only with APEX system - see APEX instruction G550	P	2.18
<b>HO</b>	This parameter is factory set - do not change without consulting the factory	P	2.00 ↕
<b>IA</b>	This is a cycle code (see foot note) from Interior Motec see appendix D CN2	D	2.58
<b>IF</b>	Use only with APEX system - see APEX instruction G550	P	2.18
<b>Ir</b>	Use only with APEX system - see APEX instruction G550	P	2.18
<b>IU</b>	Use only with APEX system - see APEX instruction G550	P	2.18
<b>J I</b>	This indicates the control tried to run the motor & received no response from the encoder. The run was aborted to save the fuse( functional 2.09 & up)	D	2.07
<b>JS</b>	Turn on this parameter to save the fuse if the door is actuated while jammed or locked (see J1)	P	2.07
<b>L I</b>	Provides <b>L</b> ocking in <b>1</b> way mode (see section 7)	P	2.03
<b>LF</b>	Automatic <b>L</b> ock <b>F</b> ailed to lock (see section 8)	E	2.00 ↕
<b>Lh</b>	Use only with APEX system - see APEX instruction G550	P	2.18
<b>LL</b>	Shows lock is present (see sect. 6)	P	2.18
<b>Lo</b>	Use only with APEX system - see APEX instruction G550	P	2.18
<b>LP</b>	Indicates <b>L</b> oss of <b>P</b> ulses from encoder (see section 11)	E	2.00 ↕
<b>nA</b>	Access restricted call factory for assistance	PD	2.05 ↕
<b>nL</b>	<b>N</b> o <b>L</b> ock found during initialization (see section 6)	D	2.00 ↕
<b>nS</b>	Door has not reached close monitor switch. See sect. 1 step 2. Check for obstructions. See appendix A step 2	E	2.06
<b>nE</b>	Door idle in night mode (Replaced in later versions by 1n & 2n) see sect. 2, step 8	D	2.00/17
<b>Ob</b>	<b>O</b> Bstruction - If door is impeded while opening / stops displays Ob and opens in OC	PD	2.22 ↕
<b>OC</b>	<b>O</b> pen <b>C</b> heck speed (see sect.2 step 8)	PD	2.00 ↕
<b>OP</b>	This is a <b>P</b> ower fail <b>O</b> pen code (see sec.14)	D	2.11 ↕
<b>OS</b>	<b>O</b> pen <b>S</b> peed (see sect. 2 step 8)	PD	2.00 ↕
<b>OU</b>	<b>O</b> pen <b>c</b> Ushion speed (see sect. 2 step 8)	PD	2.00 ↕
<b>PC</b>	Indicates control is slowing for partial open	D	2.00 ↕
<b>Pd</b>	Set up has stopped because of activation devices (see sect 2 step 5)	D	2.00 ↕
<b>PF</b>	<b>P</b> ower <b>F</b> ailure (see sect. 14)	PD	2.00 ↕
<b>Pn</b>	Power failure (see sect. 14)	P	2.13
<b>PO</b>	This parameter determines <b>P</b> artial <b>O</b> pen stroke in inches.	P	2.00
<b>rC</b>	This parameter is factory set - do not change without consulting factory	P	2.00
<b>rn</b>	Use only with APEX system - see APEX instruction G550	P	2.18
<b>rA</b>	This parameter causes the door to recycle if open pulses are received during closing cycle	P	2.06
<b>rU</b>	This is a cycle code (see foot note) from reverser circuit.	D	2.18
<b>SA</b>	Indicates fail <b>S</b> Afe lock is found during initialization (see sect. 6 ) Parameter should be turned on if a fail safe lock is present.	PD	2.00 ↕
<b>Sb</b>	This is a cycle code (see foot note) from safety beam input.	D	2.18
<b>SE</b>	Indicates fail <b>S</b> Ecure lock is found during initialization (see sect. 6 )	D	2.00 ↕

## APPENDIX B3 CODE DISPLAYS

CODE	DISPLAY MEANING	TYPE	VERSION
<b>SF</b>	Encoder failed during initialization. Do encoder test (see sect. 12)	E	2.00 ↕
<b>S I</b>	Use only with APEX system - see APEX instruction G550	P	2.18
<b>SL</b>	This parameter reduces all open speed values when turned on	P	2.18
<b>SD</b>	Stroke zeroed is displayed after forcing relearn (see short cuts)	D	2.00
<b>St</b>	Disables <b>Pd</b> during initialization	P	2.00 ↕
<b>SP</b>	Provides <b>Sidelite Protection</b> when turned on. Reduces opening speed to open check when safety beam input is activated (see app D)	P	2.03
<b>SU</b>	Displays at beginning of initialization (see sect 2, step3 in ver 2.19 and up)	D	2.19
<b>tS</b>	Total stroke shown in inches at the end of initialization (see sect2 step 6)	PD	2.00 ↕
<b>tY</b>	This display is asking for the type of operator (see sect. 2 step 4)	PD	2.15 ↕
<b>Ud</b>	Use only with APEX system - see APEX instruction G550	P	2.18
<b>UF</b>	Autolock has failed to unlock (see sect 8)	E	2.00
<b>UL</b>	When this is turned on it tells the software not to wait for the lock monitor but try to open after a brief delay. Rarely used, only for non Horton locks	P	2.00
<b>Un</b>	Use only with APEX system - see APEX instruction G550	P	2.18
<b>US</b>	Use only with APEX system - see APEX instruction G550	P	2.18

### FOOT NOTES:

•The latest versions, 2.15 and up, also have a new feature called cycle / hold codes. Immediately after the door has opened to its stopping point (full or partial open), a "cycle code" will flash briefly. This code indicates which device opened the door. The cycle code is useful if a door is ghosting and you are trying to figure out which activating device is causing the problem.

•If an actuator is holding the door open, the updated software shows a "hold code" instead of **d 1** or **d 2**, to indicate which device is holding the door open, The displays shows the various hold codes in sequence. When all devices are clear, the display will switch to **d 1** or **d 2** and the normal time delay will start.

#### The cycle / hold codes used are:

<b>iR</b> Interior Actuator (pin 2 of CN 2)	<b>dn</b> down button
<b>Sb</b> Safety beam (pin 6 of CN 2)	<b>RR</b> Auxiliary Actuator (pin 14 of CN 2)
<b>ER</b> Exterior Actuator (pin 3 of CN 2)	<b>rU</b> ReVerser (cycle code only)

•While the door is at rest in the open position, pressing and holding the **UP** button will switch the display to show the last cycle code; that is, the last device that cycled (or recycled) the door. Releasing the **UP** button takes you right back to normal operation. This is a kind of "mini-history" in case you didn't see the cycle code when the control flashed it the first time.

### SHORT CUTS

**SELF CYCLE MODE** To initiate self cycle without accessing the **ct** parameter press and hold the **UP** button then press the **DOWN** button and release them at the same time. If you haven't saved any parameters, you can get out of this mode by pressing the **RESET** button only. Otherwise you must go to the **ct** parameter and turn off and do a data save.

**CYCLE DOOR** Push the **DOWN** button. The door will open, and stay open until **d 1** expires and then close.

**LEARN NEW STROKE ONLY**(Version 2.03 and later) Hold **SET** and **UP** buttons. Press and release **RESET**, continue holding **SET** and **UP** buttons for 5 seconds. The door will go through the learn cycle without resetting any other parameters.

**OVERRIDE PD**(Version 2.11 and later) If you encounter "**Pd**" (or other hold codes) during initialization procedure, press and hold the **UP** button to override "**Pd**" and allow the door to set up. This prevents you from having to disconnect motecs or safety beams.

**RETURN TO THE TOP OF THE MENU**(Version 2.10 and later) Press **UP** and **DOWN** together to return to the top of the menu.

**PARAMETER ACCESS** (Version 2.12 and later) The menu may be accessed and parameters changed by rapidly double clicking the **SET** button when the door is fully closed or opened. To exit double click the **SET** button again and the control will return to normal mode. Turning the toggle off and on will override this function.

**FORCED RELEARN** To be absolutely sure that you have executed a relearn of the stroke, hold the **UP,DOWN** and **SET** buttons, then press **RESET** - hold for 5 seconds and release. The display will then start to flash **SD** and will continue to do so until the **RESET** button is pressed again. Then the control will execute a relearn as described in section 2 step 3.

H202.12

## APPENDIX C MOTOR TEST

This test is conducted to determine the resistance across the motor. A low or zero resistance will cause high current draw and damage to the control.

- Place OHM meter in range to measure :  
10 to 50 analog Rx1 range  
R200 digital.

- Unplug the motor and place probes in pins 1 and 2

- Read and record the resistance.

- Rotate the motor a little bit to move to the next section of the commutator.  
(Feel for the brushes to make contact with the next segment on the commutator.)

- NOTICE:** a voltage will be induced into the meter when the motor is moved, so wait for the meter to stabilize before taking a reading.

- Continue taking readings for about 1/4 revolution of the out put pulley. (Pulley is 8:1 ratio)

- Acceptable ranges are shown by each motor type.

NOTE: A low reading is critical and will cause damage to the control.

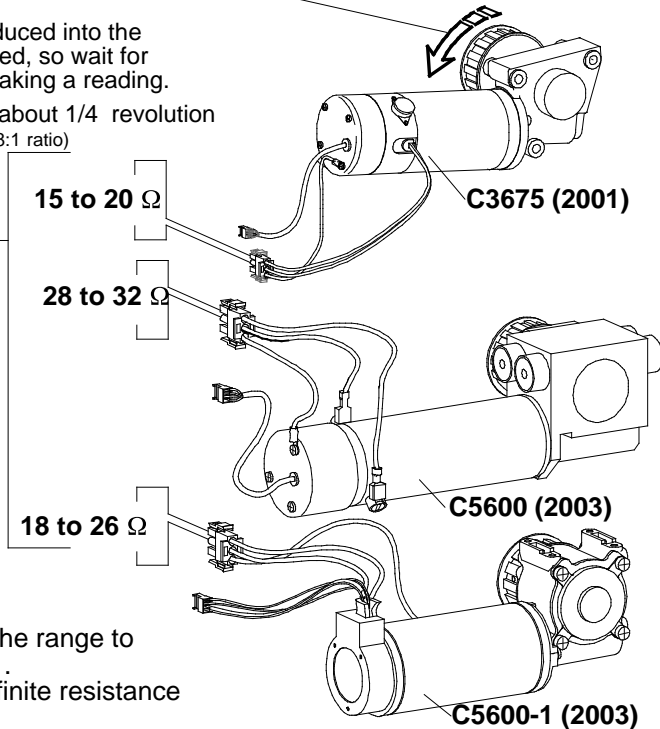
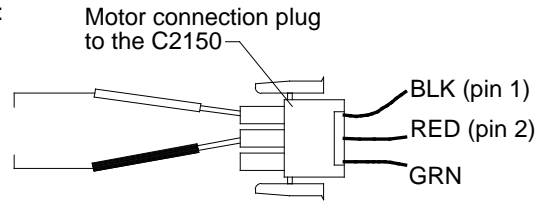

## FRAME SHORT TEST

- Place the OHM meter in the range to measure at least 20,000 .  
The meter should show infinite resistance when connected .

- Place probes in pins 1(BLK) & 3(GRN/YEL)

THEN...

The meter should not move when the probes are connected.

- Place probes in pins 2(RED) & 3(GRN/YEL)

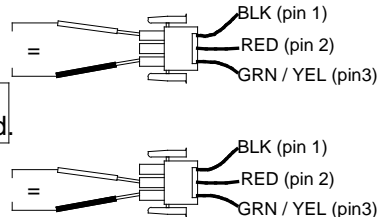

## APPENDIX D TERMINAL CN2

### NOTE:

- This symbol indicates 24 volts DC
- A point behind a number indicates common (ground)

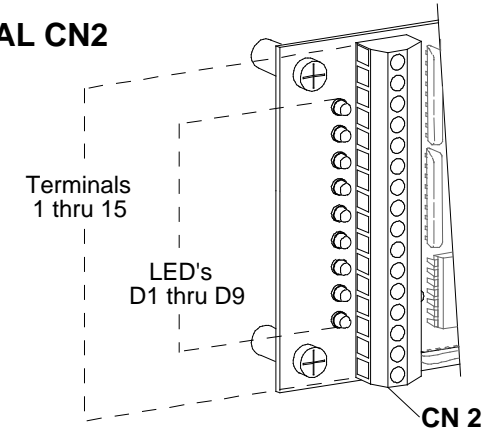

LED	TERMINAL	DESCRIPTION
	= 1	24 VDC
D1 (G) INT MOT	2	Interior Activation
D2 (R) EXT MOT	3	Exterior Activation
	4.	Common
	= 5	24 VDC
D3 (Y) SAF BEM	6	Safety beam & sidelite protection
	7.	Common
D4 (G) TOG SW	8	Toggle switch
	9.	Common
D5 (Y) CLS MON	10	Close monitor switch
	11.	Common
D6 (G) SW A	12	Partial open cutoff
D7 (Y) SW B	13	1 Way (Closed for one way- light on )
D8 (R) SW C	14	Auxillary activation
	15.	Common
D9 (O) KEY SW	16	Day night mode (closed for day mode- light on)

## APPENDIX E ENCODER ASSEMBLY

Disassemble the encoder as shown to replace the circuit board.

NOTE: 2001 C3675 ENCODER IS SIMILAR.

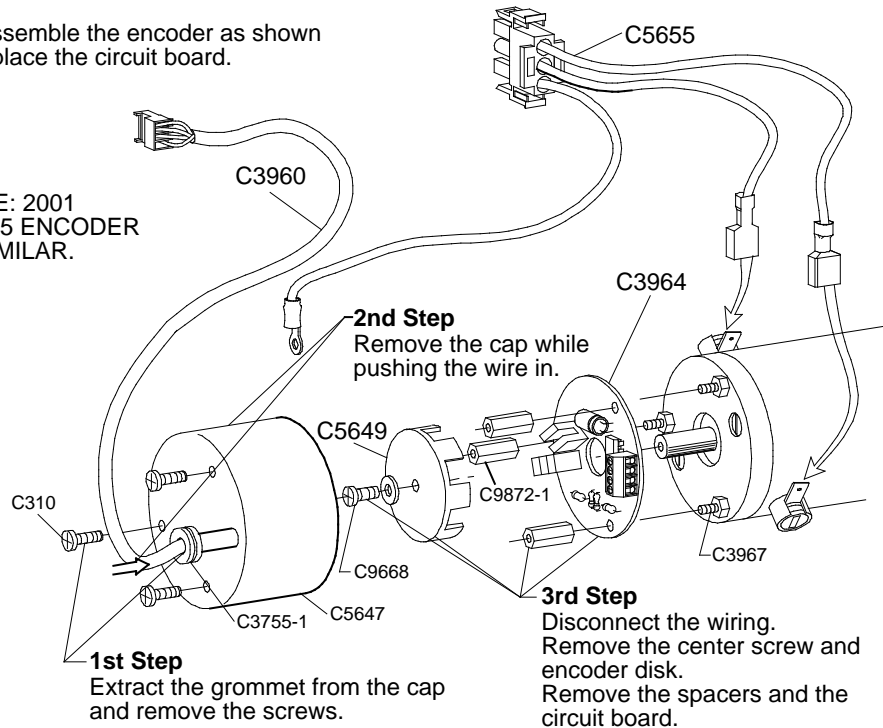

### 4th Step

Replace the circuit board and reassemble the encoder .

**NOTE:** Run the initialization learn cycle (see sect. 2 ) after replacing the board.

## APPENDIX F BRACKET ATTACHMENT

If the unit has been disassembled for painting or other reasons, the power brackets **MUST** be reattached as shown.

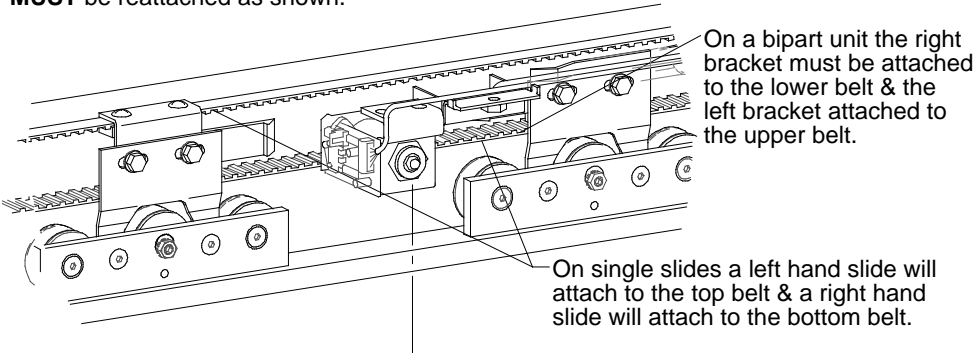

## APPENDIX G WIRING DIAGRAM LIST

DRAWING No.	BEAMS		ACTIVATE				KEY SW		AUTO-LOCK	
	C&K C1185	4 BEAM C1284	C&K C1188-1	VGO37 C1801	VGO87 C1802	CPSS12	C3725-L 4 POS	PARTL OPEN		
11100.0	X		X							
11100.1	X			X						
11101.1	X		X				X			
11104.1	X		X				X	X		
11105.0	X		X							5 Position SW
11107.0	X		X						X	Security panel C1280
11228.0	X		X						X	
11229.0		X		X					X	
11231.0		X		X						C3881 w/ mag lock
11232.0			X							Security panel C1280
11247.0	X			X						Limited access
11249.1	X					X	X			

H202.14



# DIAGRAM 1 C2150 TYPICAL WIRING for BELT DRIVE

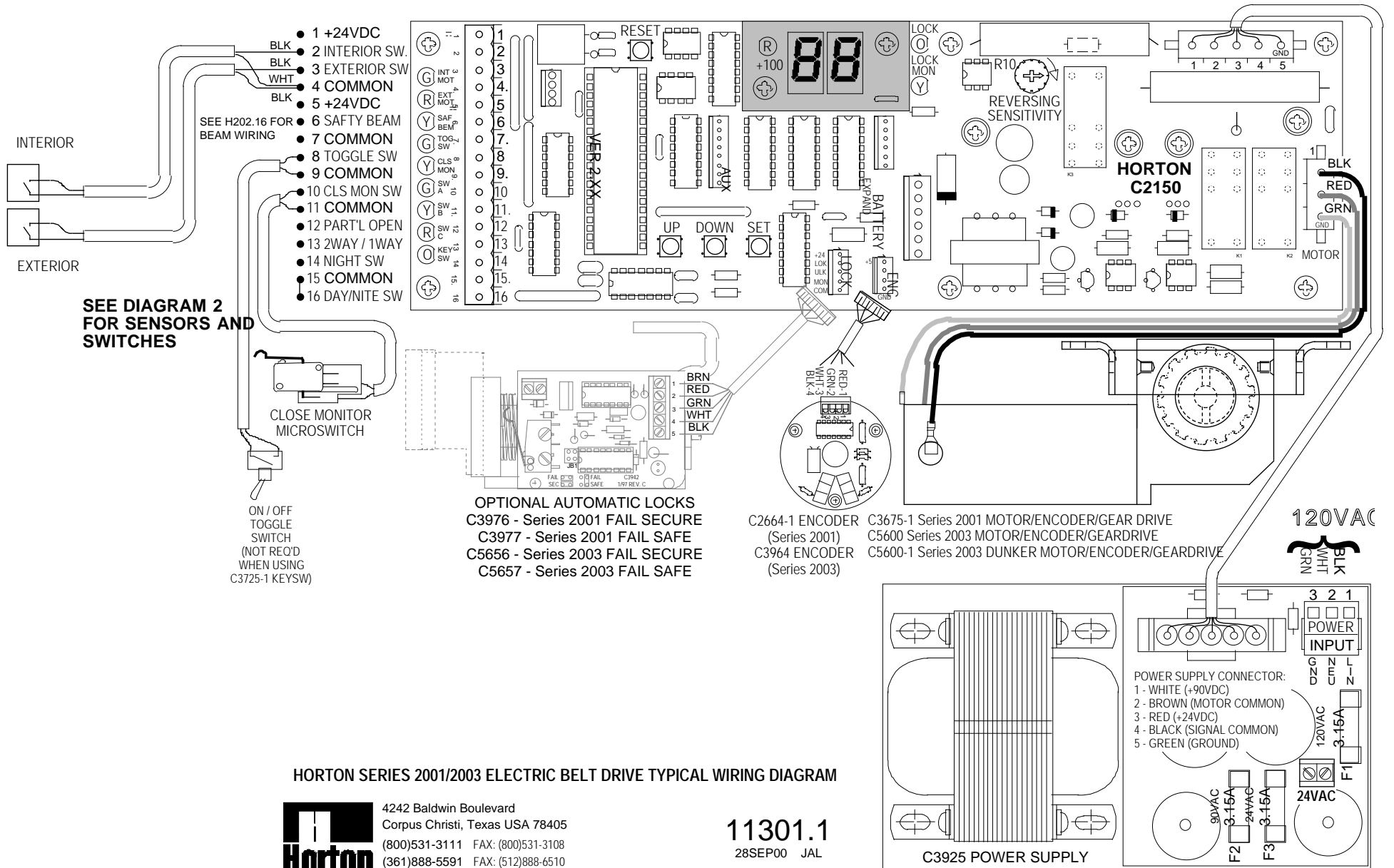

HORTON SERIES 2001/2003 ELECTRIC BELT DRIVE TYPICAL WIRING DIAGRAM



4242 Baldwin Boulevard  
 Corpus Christi, Texas USA 78405  
 (800)531-3111 FAX: (800)531-3108  
 (361)888-5591 FAX: (512)888-6510  
 Internet - <http://www.hortondoors.com>

11301.1  
 28SEP00 JAL

H202.15

**DIAGRAM 2 ACTUATING and CONTROL SWITCH CONNECTIONS**

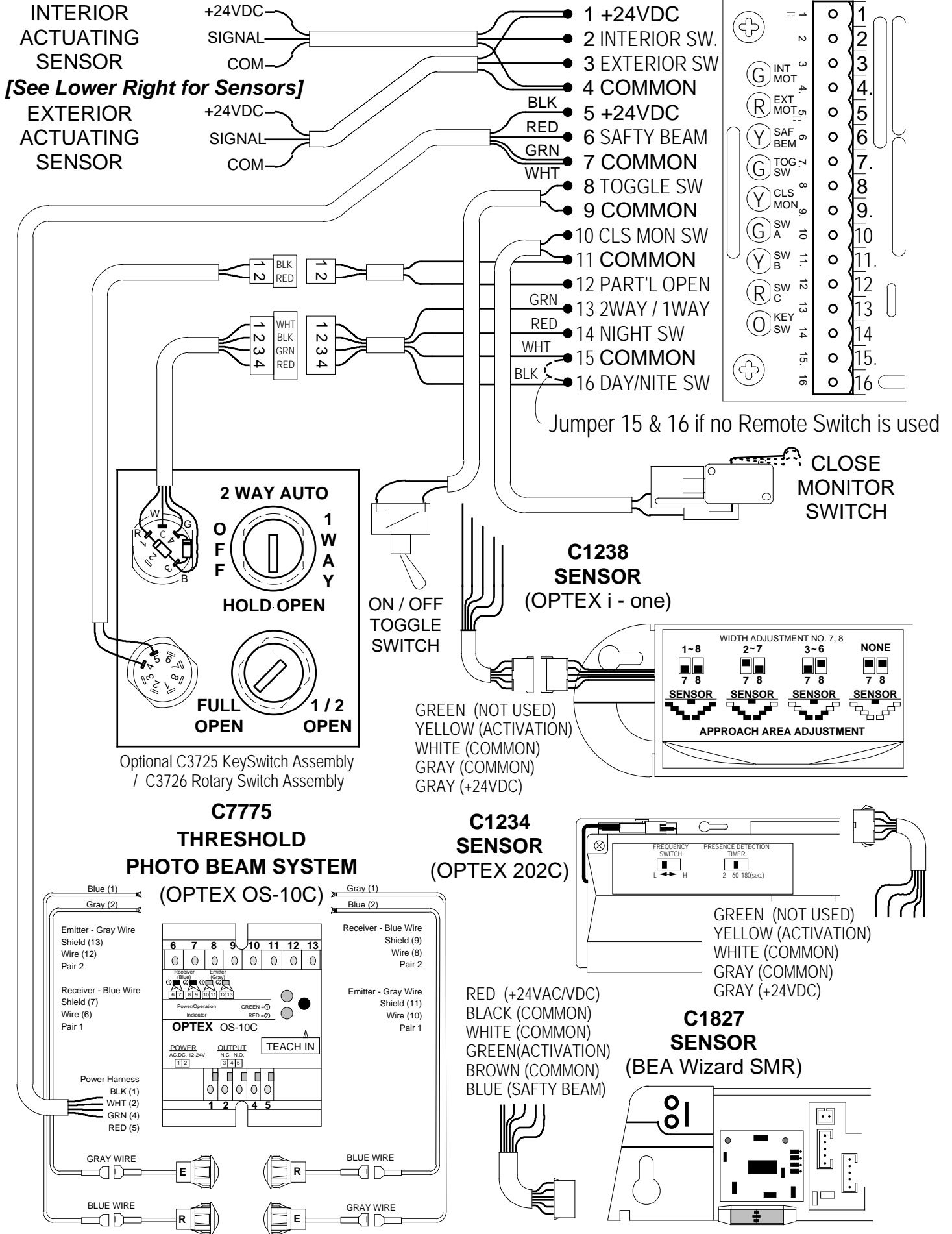

# DIAGRAM 3 TYPICAL WIRING for BEAMS and SWITCHES

## Optex OS10-c 2 channel photo electric system (standard wiring with amplifier)

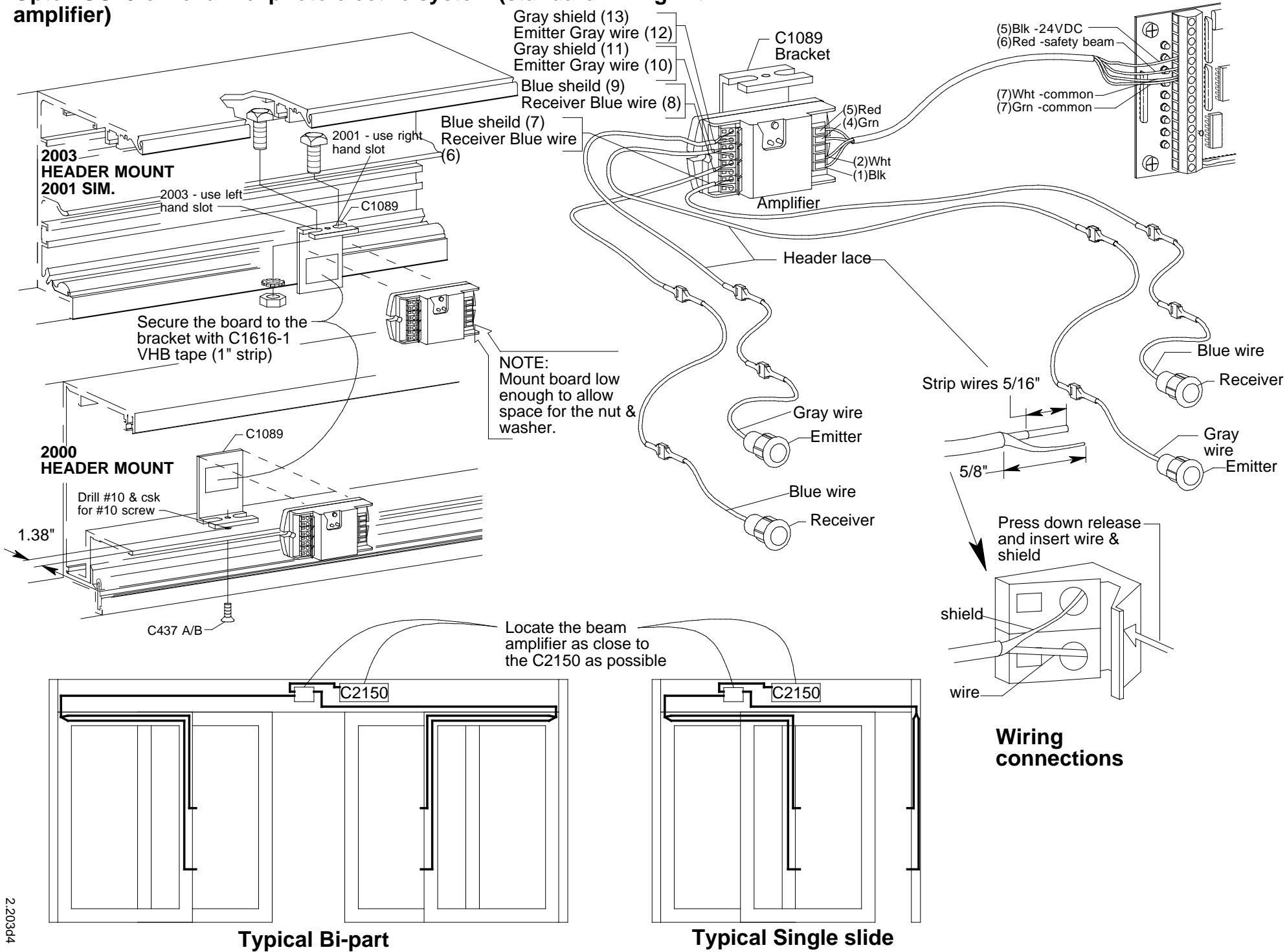

H202.17



4242 Baldwin Boulevard  
Corpus Christi,  
Texas, U.S.A. 78405-3399  
Tel: 800-531-3111, 361-888-5591  
Fax: 800-531-3108, 361-888-6510  
Internet: <http://www.hortondoors.com>

**Horton Automatics, Ltd.**  
Unit A, Hortonwood 31  
Telford, Shropshire, England TF1-4GS  
Tel: 01952 670169, Fax: 0192 670181  
International Tel: ++44-1952-670169  
International Fax: ++44-1952-670181

**A Division of Overhead Door Corporation, A Sanwa Shutter Company**

**Form H202, AUG 2004**, printed in U.S.A.

Horton Automatics reserves the right to improve the product and change its specifications without notice.