

# **C2150 *Quick-Start***

## **Instructions & Trouble Shooting**

### **for 2000**

## **Electric Slide Door Operators**

### **With Version 1 software and micro switches**

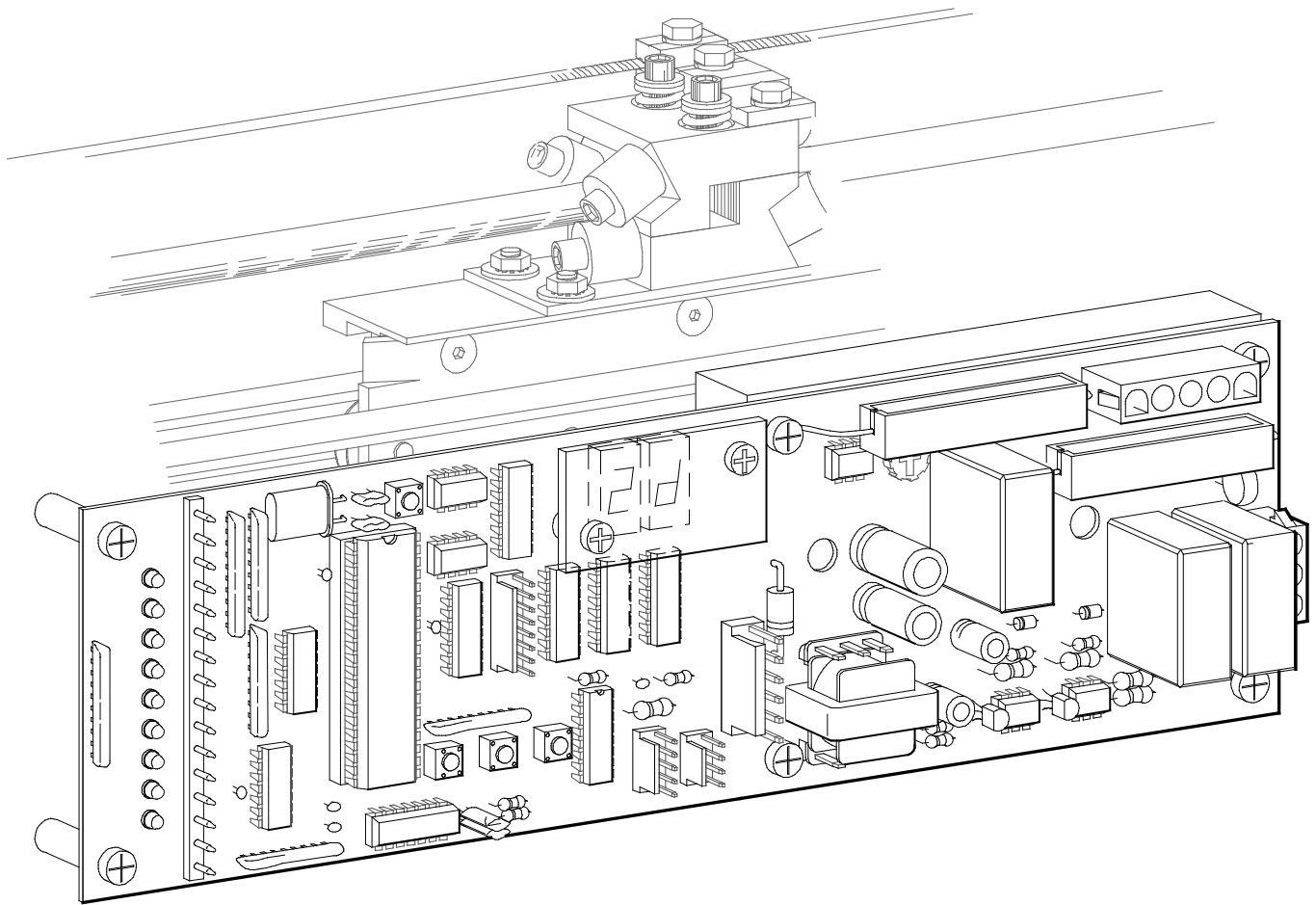

# CONTENTS

## SECTIONS

1. Series 2000 slide operator quick start instructions.....	H201.1
2. C2150 initialization .....	H201.2
3. Adjusting parameters (Procedure for changing preset parameters).....	H201.3
4. Adjustable preset parameters (chart of adjustable ranges).....	H201.3
5. Actuation features.....	H201.4
6. Autolock set up and initialization.....	H201.4
7. Setting lock parameters.....	H201.5
8. Lock error codes (Trouble shooting guide).....	H201.5
9. Autolock test points.....	H201.5
10. Autolock functions.....	H201.5
11. Micro switch diagnostics.....	H201.6
12. Partial open switch.....	H201.6
13. Power failure units (Set up and testing).....	H201.7

## WIRING DIAGRAMS

1. C2150 typical wiring for 2000 linear drive.....	H201.8
2. Actuating and control switch connections.....	H201.9

## APPENDIX

A. In case of difficulty (Trouble shooting the C2150).....	H201.10
B1. Code displays (definitions and trouble shooting guide).....	H201.11
B2. Code displays (definitions and trouble shooting guide).....	H201.12
B3. Code displays (definitions and trouble shooting guide - short cuts).....	H201.13
C. Wiring diagram list.....	H201.13
D. Terminal CN2 (Description of terminal block connections) .....	H201.14
E. Motor test.....	H201.14

## GENERAL STATEMENT

The C2150 is a microprocessor that uses a series of inputs, outputs and custom software to control a slide door. The inputs are usually supported by LEDs that lets the technician see what information is coming into the control and the outputs are in the form of display codes, LEDs and actual control of the motor, autolocks etc. This manual is written for the C2150 control with Version 1 software which is used in the controls of the 2000 series linear drive operators. The C2150 control receives its power from a separate power supply (usually a C3955) which provides +27 to +35 VDC to power all of the accessory devices as well as power for the control itself. The power supply also delivers +100 to +120 VDC to the control which is reduced by a MOSFET (duty cycle control) and is called into service at variable levels through software and parameter selection. It is our hope that this manual will guide the experienced technician through the efficient and safe setup of the C2150 slide door control. Remember that all installations must comply with ANSI 156.10.

Other instructions to be used with this publication are: G200 - 2000 slide door  
G550 - APEX sensor system

# 1. SERIES 2000 SLIDE OPERATOR QUICK START INSTRUCTIONS

C2150 Control with version 1 software (Revision E or later hardware)  
 To get the operator up and running, check the items outlined below-

## 1st Step

A toggle switch or jumper must be present between pins 8 & 9. Switches are sent loose and field mounted. Break-outs are wired in series with the toggle switch.

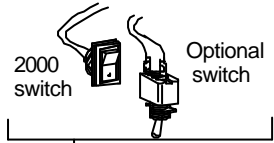

## 9th Step

Verify jumpers JB1A & JB1B ARE installed on rev. E and later controls.

## 8th Step

Set the reversing sensitivity fully counter-clockwise.



## 7th Step

Check incoming voltages from power supply

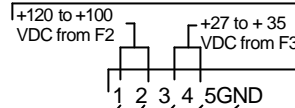

## 6th Step

A 5 conductor cable attaches CN7 to the power supply.

## 6th Step

Check that the incoming power is wired as shown.

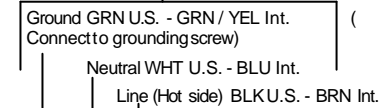

## 4th Step

The motor must be plugged into connector CN8

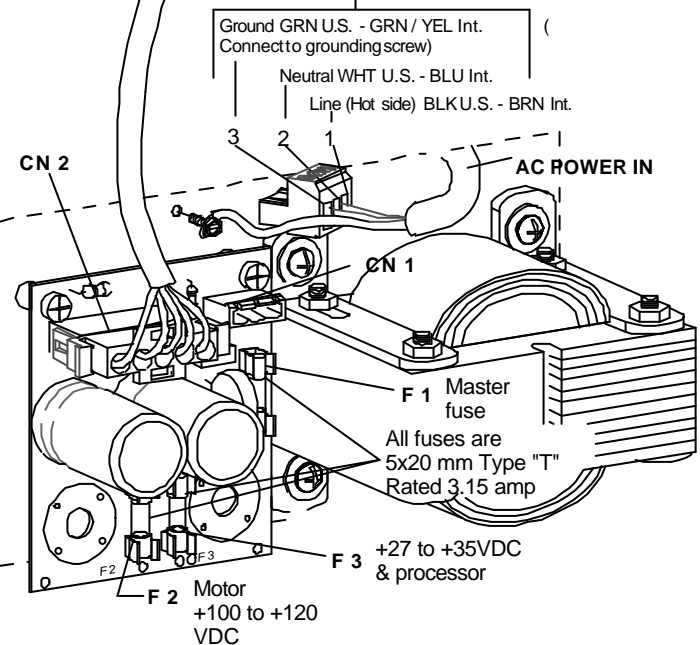

## 2nd Step

If the day / night mode is **NOT** to be used - there **MUST** be a jumper between 15 & 16. See Sections 5 thru 10 for actuating features and lock set-up.

## 3rd Step

The micro switches must be plugged into CN11 on the control.

## NOTE:

Do **NOT** wire any motion detectors or any other accessories at this time. Factory pre-wired beams (pins 5,6 & 7) may be left in place.

## 2. C2150 INITIALIZATION

### 1st Step - Power up

Be sure the toggle circuit is completed and apply AC power to the unit.

**CAUTION: THE DOOR WILL MOVE.**

### 2nd Step - Learn cycle

Instruct the control to perform a full learn cycle by:

- Holding down the **SET** button and the **RESET** button.
- Release the **RESET** button.
- Hold the **SET** button for an additional 5 seconds then release.

### 3rd Step - Version display

#### VERSION 1.00 and earlier

The display should "blink" the version number (as in 1 then 00) \*The display will show the lock code (see below)

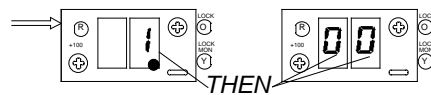

#### VERSION 1.17 and LATER

In version 1.17 and later, the display will show **SU**

- If **SU** does not appear, then the control was not properly reset into the full learn mode (Go back to step 2)

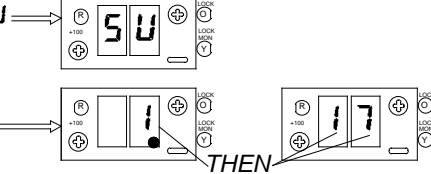

• The display should "blink" the version number (as in 1 then 17)

• If the display flashes **nA** like an error code, The **nA** (no Access) parameter has been turned on.

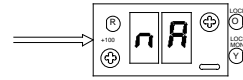

• A full learn cycle can not be completed with this security parameter in place. Consult your supervisor or the factory for authorization and instructions on how to remove this security parameter.

### \*LOCK CODES

• The control will display **ONE** of the following lock codes depending the type of lock connected. (see Section 6)

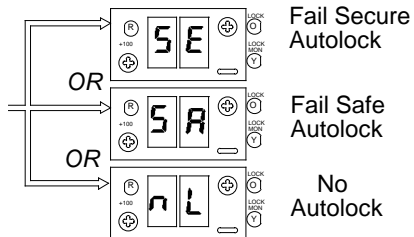

### 4th Step -Checking door cycle

When the toggle switch is on, the **DOWN** button acts as an actuation device. **The door will move** - Be sure the safety beam area is clear of obstructions. Activation devices should not yet be installed.

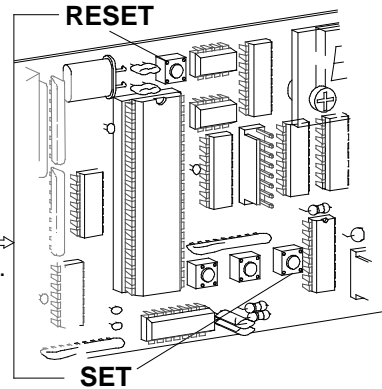

Start with the door in the closed position. Press the **DOWN** button to actuate the door to open at factory selected default settings.

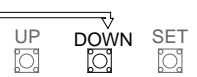

The chart below shows the position of the door and the display code for each position.

Inspect the unit for smooth operation, free of binds and excessive noise.

The follow cycles are carried out automatically by the C2150 control

• The display starts with:

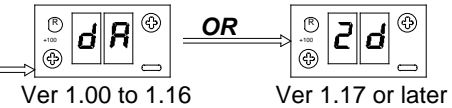

### Open Cycle

• Open Speed

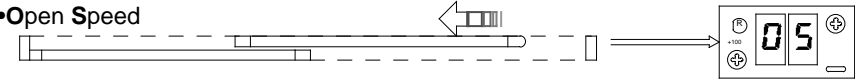

• Motor Braking



• Open Check \*



\*Braking may override open check display

• Open cUshion



• Time Delay

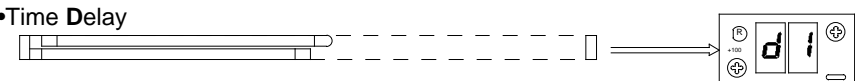

### Close Cycle

• Close Speed

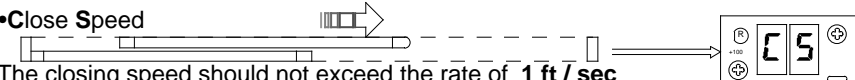

The closing speed should not exceed the rate of **1 ft / sec**

• Close Check

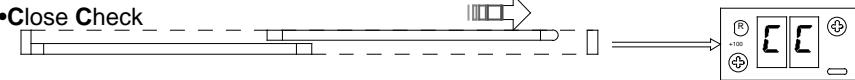

• Close cUshion

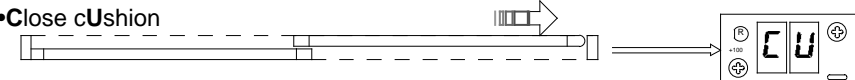

• The display returns to:

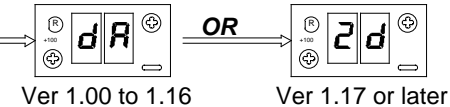

• If the above cycle check is OK and there are no parameters to be changed or an autolock to setup, this concludes the C2150 initialization.

**IF THERE IS ANY DIFFICULTY SEE APPENDIX A**

### 3. ADJUSTING PARAMETERS

#### 9th Step - Changing parameter settings

A chart of preset values is shown to the right.

If any speeds or other settings need to be changed, follow this procedure:

- Turn the toggle switch **OFF**

Or for versions 1.10 and up, leave the toggle **ON** and double click the **SET** button.

- The display will switch to the menu of adjustable parameters

- In versions 1.08 and up, the right decimal point will be blinking

- Refer to the chart in section 4 for a list of codes for adjustable parameters.

- Scroll through the parameter list using the **UP** and **DOWN** buttons until the parameter to be changed is found.

- When the parameter to be changed is found, press and hold the **SET** button.

- The display will show the current value or setting of the parameter.

- While holding the **SET** button, press the **UP** or **DOWN** button to modify the setting.

- When the **SET** button is released, the display will show the parameter that was just changed. Another parameter may be changed, or the toggle circuit turned on to check the changes just made. In versions 1.10 and up the **SET** button may be double clicked to exit the menu (toggle must be on).

#### 10th Step - Saving new settings

- When all adjustments have been made and checked, be sure the toggle circuit is on.

- With the display reading **d5** or **dR** press and **HOLD** the **SET** button until **d5** (data save) is displayed. All of the changes are now stored in the control's memory. **This step must be performed** or the control will revert to the default settings after a power failure.

- Set the reversing sensitivity as required using R10. **Do not** leave this adjustment at minimum. Horton recommends setting the sensitivity so the door will **reverse at 28 ft.lb.** or less.

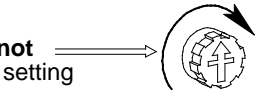
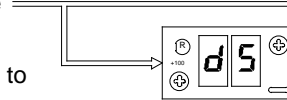
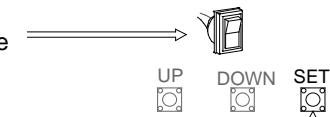
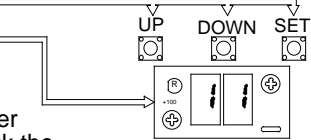
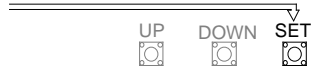
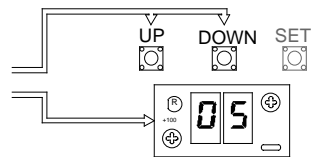
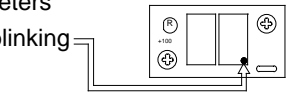
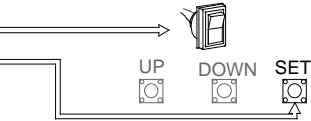

### 4. ADJUSTABLE PRESET PARAMETERS

The chart below shows all the adjustable parameters for **version 1 software**. Follow the procedure outlined in step 9 to make any necessary changes.

CODE	PARAMETER	FACTORY PRESET VALUE	ADJUSTS
<b>05</b>	Open Speed	10	0-15
<b>05</b>	Close Speed	12*	0-15
<b>0C</b>	Open Check	4	0-15
<b>0C</b>	Close Check	4	0-15
<b>0U</b>	Open cUshion	3	0-15
<b>0U</b>	Close cUshion	3	0-15
<b>d1</b>	delay time 1 (full open)	1 sec	1-60**
<b>d2</b>	delay time 2 (partial open)	1 sec	1-60**
<b>RC</b>		1 (factory set - do not change)	
<b>HD</b>		3 (factory set - do not change)	
<b>rC</b>		3 (factory set - do not change)	
<b>bT</b>	brake time	20	0-100
<b>cT</b>	cycle test	oF (no)	oF/on
<b>RS</b>	Auto Seal	oF (no)	oF/on
<b>Hd</b>	Heavy-duty door/motor	oF (no)	oF/on
<b>PF</b>	Power Fail	OP (power fail OPen)	OP/CL
<b>Pn</b>	Power fail Night mode	on (version 1.12 & up only)	oF/on
<b>Cb</b>	Close braking	oF (on)(Version 1.02 & up only)	oF/on
<b>br</b>	brake on recycles	oF (on)(Version 1.02 & up only)	oF/on
<b>LL</b>	Lock present	oF (on if Horton lock is present)	oF/on
<b>SR</b>	fail-SAFE lock	oF (fail-secure) (on fail-safe)	oF/on
<b>UL</b>	Unmonitored Lock	oF (monitored lock)	oF/on
<b>dL</b>	daytime Lock	oF (lock stays unlocked in day mode)	oF/on
<b>L1</b>	daytime 1-way Lock	oF (version 1.02 & up only)	oF/on
<b>RP</b>	Apex Enable	oF (version 1.16 & up only)	oF/on
<b>Lt</b>	Longer Timeouts	oF (version 1.17 & up only)	oF/on
<b>SP</b> ✓	Sidelite Protection	oF (version 1.17 & up only)	oF/on
<b>nR</b>	no Adjustment permitted	oF (version 1.04 and up only)	oF/on

\***Caution:** very light doors may require a lower speed setting

\*\*In versions 1.07 & prior, **d1** and **d2** adjust from 1-199 seconds.

\*\*Beginning with version 1.08, these parameters may be set to 1-8, 10, 12, 14, 16, 20, 25, 30 or 60 seconds.

Prior to 1.17, sidelite protection device was wired to 10 & 11 of CN2. 1.17 and later is wired to 6 & 7.

• A double dash (--) is a reserved parameter that is not implemented.

## 5. ACTUATION FEATURES

Set jumpers or key switch for the type of operation required. See diagram 2 page H201.9

**2-way day mode factory setting is:** jumper or switch from 15 to 16.

**1-way day mode setting is:** jumper or switch from 13 to 15 and 15 to 16.

**2-way night mode setting is:** NO jumpers or switches

**1-way night mode setting is:** jumper or switch from 13 to 15  
NO jumper or switch from 15 to 16

### NOTE:

Many other features, for autolock and motion detector configuration, are available through additional adjustable parameters. These parameters can be discussed in greater detail by calling the technical service group.

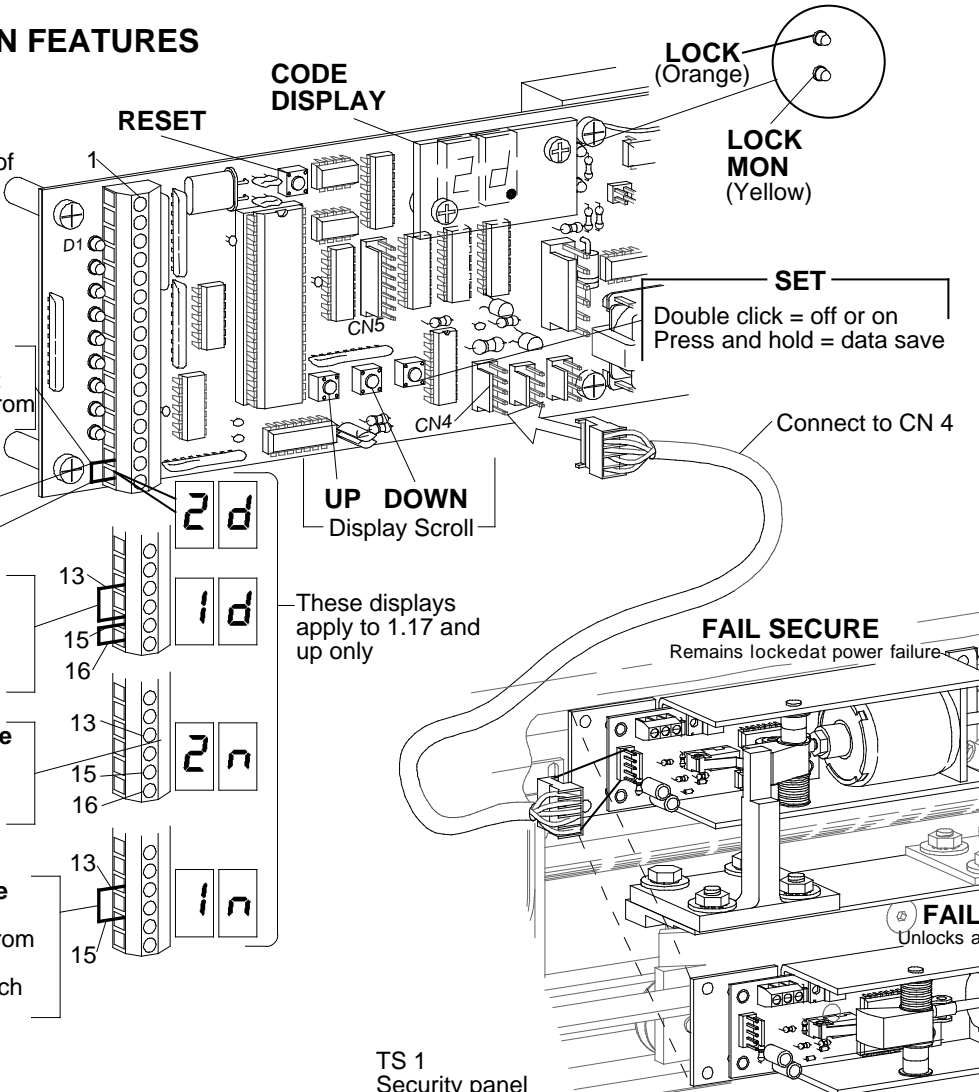

TS 1 Security panel connections (optional)

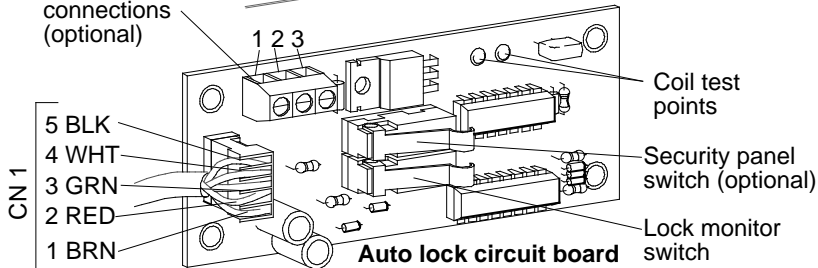

## 6. AUTOLOCK SET UP AND INITIALIZATION

Press **SET** and **RESET** simultaneously, release **RESET**, wait 5 seconds, then release **SET** - version number will displayed. During initialization the control clears all ports and the solenoid becomes inactive.

### FAIL SECURE

The C2150 looks to see if there is a contact at the lock port CN4 and if the yellow lock monitor LED is off.

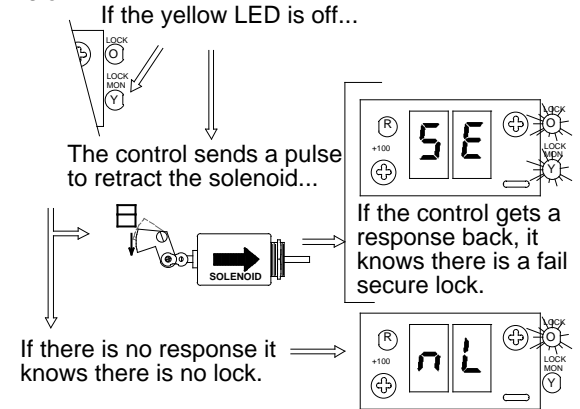

### FAIL SAFE

The C2150 looks to see if there is a contact at the lock port CN4 and if the yellow lock monitor LED is on.

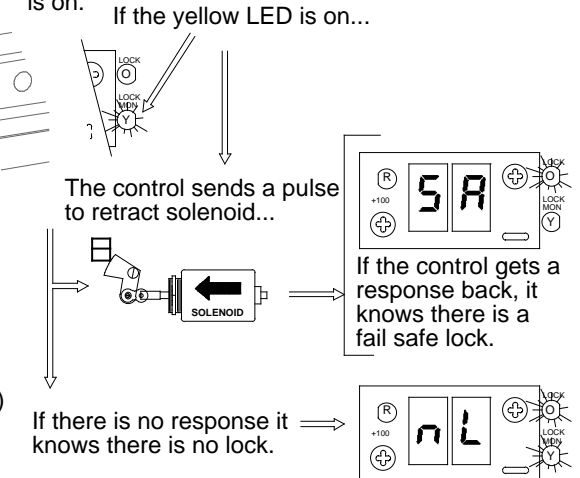

## 7. SETTING LOCK PARAMETERS

To set up the lock parameters on the C2150 turn off the toggle circuit or double click the **SET** button. Use the **UP / DOWN** buttons to locate **dL & L1**. Press the set button to display the on or off setting. Set **dL / L1** as required from the table below.

Traffic Mode		dL:of	dL:of	dL:on
SEE STEP 1 FOR SET UP		L:of	L:on	L: doesn't matter
Day	2-Way	Unlocked	Unlocked	Locked
Day	1-Way	Unlocked	Locked	Locked
Nite	2-Way	Locked	Locked	Locked
Nite	1-Way	Locked	Locked	Locked

SEE SECTION 3 STEP 10 FOR ( d5 ) DATA SAVE PROCEDURE

## 8. LOCK ERROR CODES

<b>LF</b>	<b>Lock Failure (Fail Secure)</b> Indicates that the lock monitor input is remaining active (lock monitor light is still on) even though solenoid has de-energized.
<b>UL</b>	<b>UnLock Failure (Fail Secure)</b> Indicates that the lock solenoid failed to move the plunger enough to activate the lock monitor switch and notify the control that the door is ready to be opened.
Check for mechanical binding. Check items under AUTOLOCK TEST POINTS and AUTOLOCK FUNCTIONS FOR FAIL SECURE autolocks.	
<b>LF</b>	<b>Lock Failure (Fail Safe)</b> Indicates that the lock solenoid failed to move the plunger enough to activate switch on the lock monitor.
<b>UL</b>	<b>UnLock Failure (Fail Safe)</b> Indicates that the lock solenoid spring has failed to move the plunger enough to activate the lock monitor switch and notify the control that the door is ready to be opened.
Check for mechanical binding. Check items under AUTOLOCK TEST POINTS and AUTOLOCK FUNCTIONS FOR FAIL SAFE autolocks.	

## 9. AUTOLOCK TEST POINTS

Basic voltage readings regardless of type. Set VOM at 200VDC.

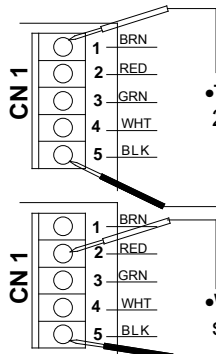

NOTE: The terminal strips TS1 & TS2 are located on the autolock

•There should always be a supply voltage of 25 to 33 VDC between pins 1 and 5 at TS1.

•When the control's orange lock light is on there should be 3 to 5 VDC between pins 2 and 5 at TS1.

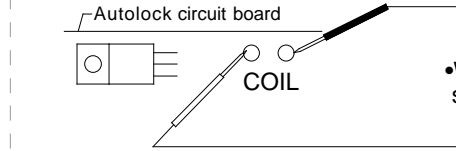
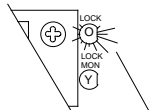

•When the solenoid initially energizes there should be 25 to 33 VDC at TS2. After about a second the voltage will drop to about 30% of the supply voltage between pins 1 and 2 of TS2.

## 10. AUTOLOCK FUNCTIONS

The **FAIL SECURE** is the most common type of auto lock used with the C2150.

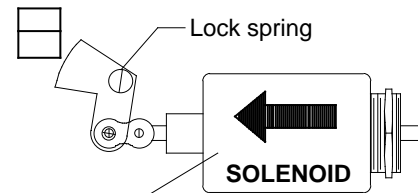

When power is removed, the solenoid is extended by the lock spring. The door is locked.

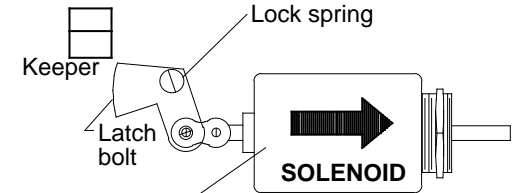

When power is applied the solenoid is retracted and the door is unlocked.

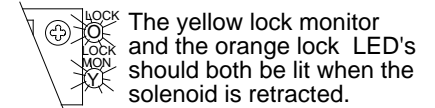
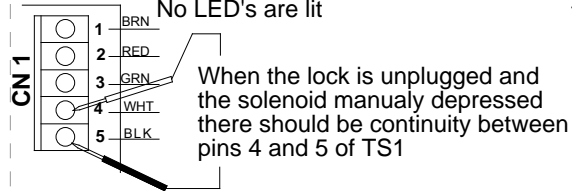

H2015

The **FAIL SAFE** is a less common type of auto lock used with the C2150.

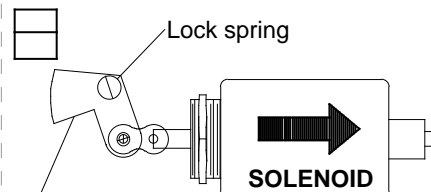

When power is removed the solenoid is retracted by the lock spring. The door is unlocked.

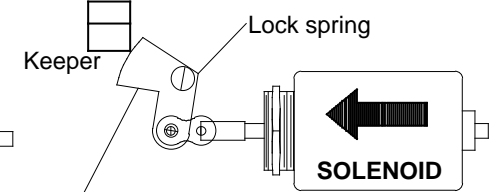

When power is applied the solenoid is extended and the door is locked.

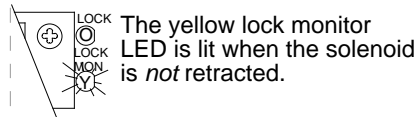

When the lock is unplugged and the solenoid is *not* manually depressed there should be continuity between pins 4 and 5 of TS1

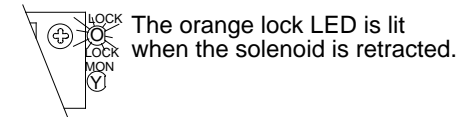

# 11. MICRO SWITCH DIAGNOSTICS

## Running a microswitch test

In software Version 1.00 or later, press the **RESET** & the **DOWN** button, release the **RESET** and hold the **DOWN** button until the display shows **Ut**

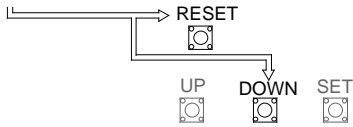

**OR...**

Power up the control while holding the **DOWN** button.

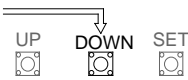

The display will, briefly, show **Ut** (for microswitch test)

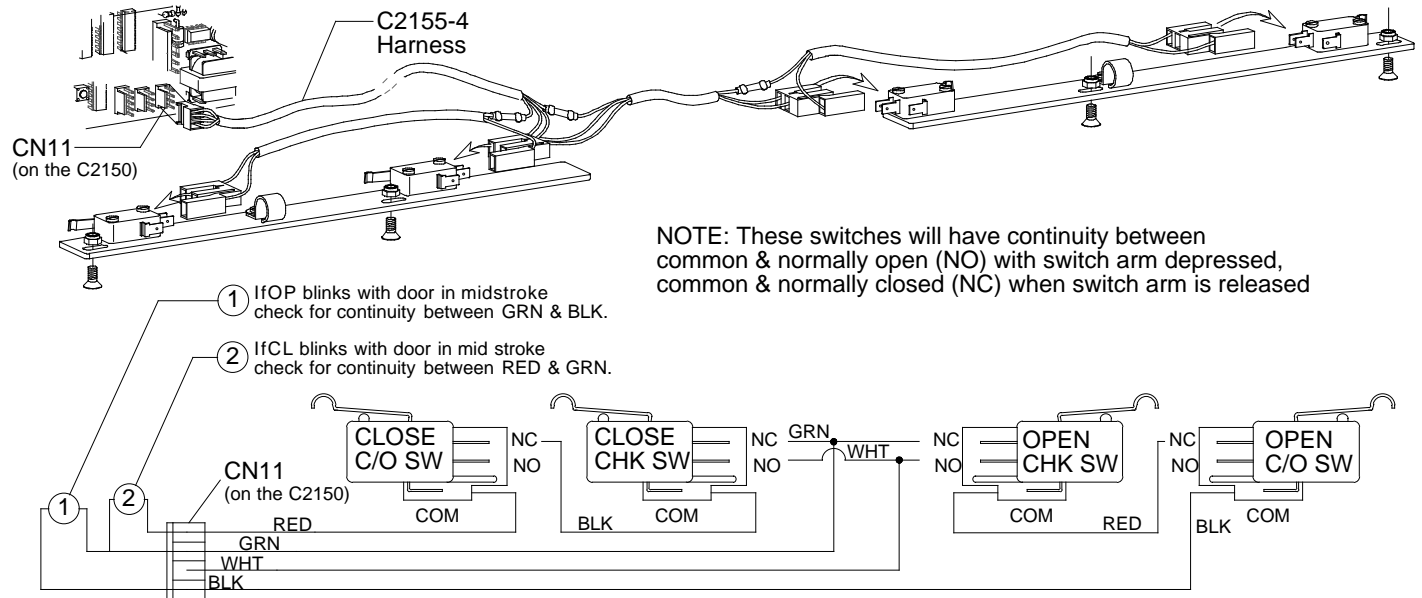
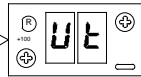

- Move the door manually through the open and closed positions to verify that each code is present for the position listed. (See the chart below)
- Missing codes, or codes that appear in improper order, indicate a problem with a switch assembly or a defective switch lace, or possibly the C2150.
- A blank display means that the door is in mid-stroke (no switches are tripped).

### Open Cycle

#### • Open Check

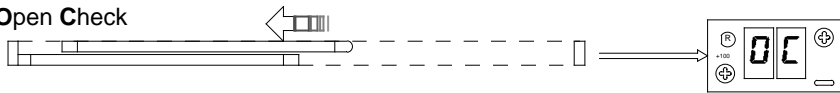

#### • Full OPen

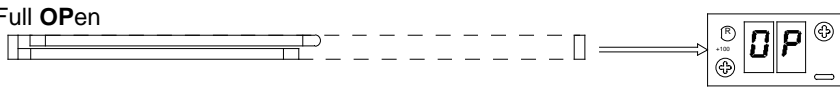

### Close Cycle

#### • Close Check



#### • Fully CLosed

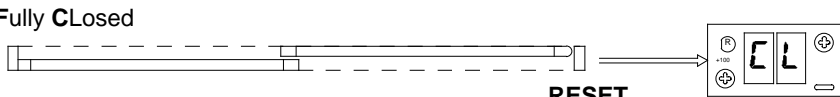

To exit the microswitch test press **RESET**



# 12. PARTIAL OPEN SWITCH

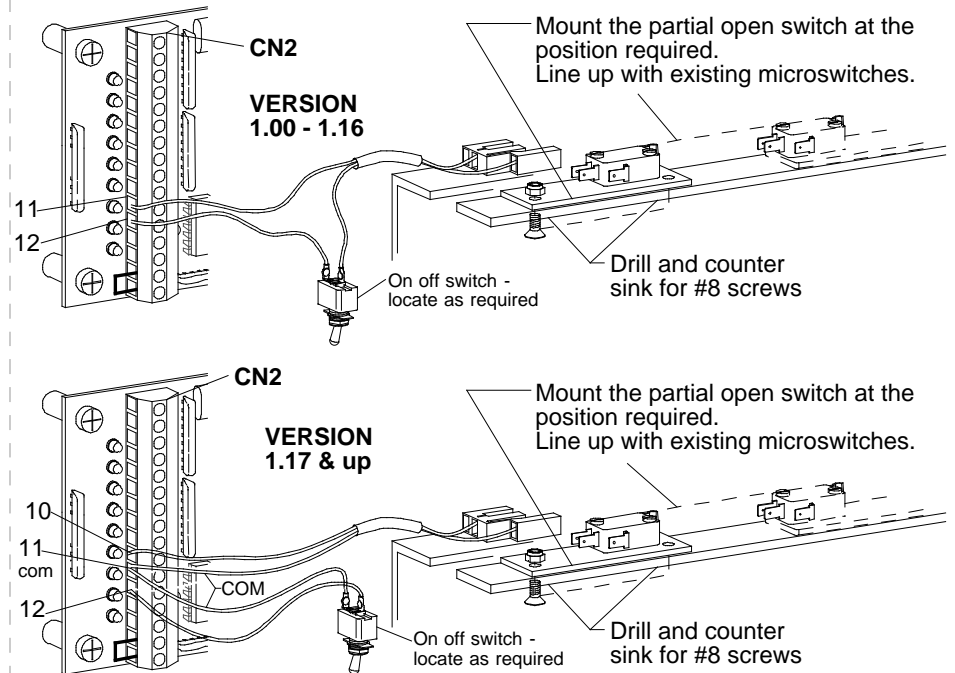

H2016



## 13. POWER FAILURE UNITS

The function of a power failure unit is to open or close the door (as selected) in the event of a power failure.

### 1st Step

Mount the unit to the header.

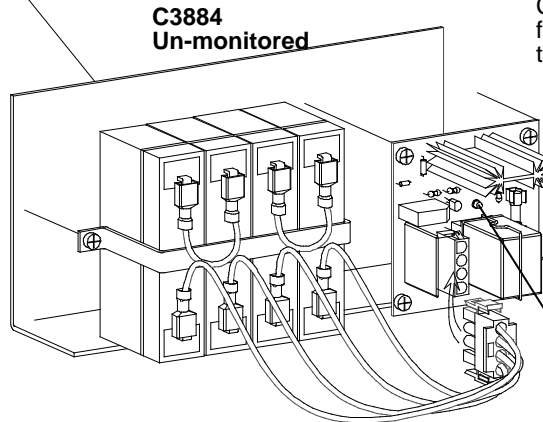

### 2nd Step

Connect the C3989 wiring harness from CN1 on the power fail unit to CN3 on the C2150

RED LED  
Charge indicator

### 4th Step

Go to the **PF** parameter in the C2150 (see section 4)

- Set to **DP** for the door to **open** when the power fails.
- Set to **LL** for the door to **close** when the power fails.
- To inhibit the power failure feature at night, go to the **Pn** parameter and turn it off.

The batteries could take up to 10 hours to charge before they can be tested.

### 3rd Step

Connect C3889 jumper from J1 on the C2150 to J1 on the power supply.

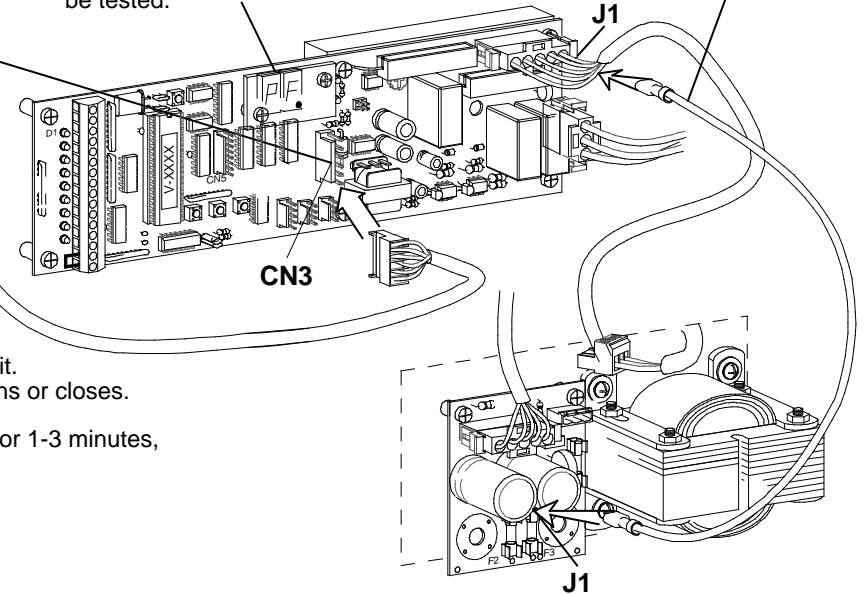

### Testing the un-monitored power fail unit

- Unplug the power at CN1 on the power supply, or turn off the breaker supplying power to the unit.
- The C2150 display should switch to **PF** within one second, and then to **LL** or **DP** as the door opens or closes.
- With the door full open or closed, the entire control should go dead until power is restored.
- When power is restored, the red charge indicator on the circuit board should come on and glow for 1-3 minutes, then dim and go completely out if the batteries were fully charged when the test began.

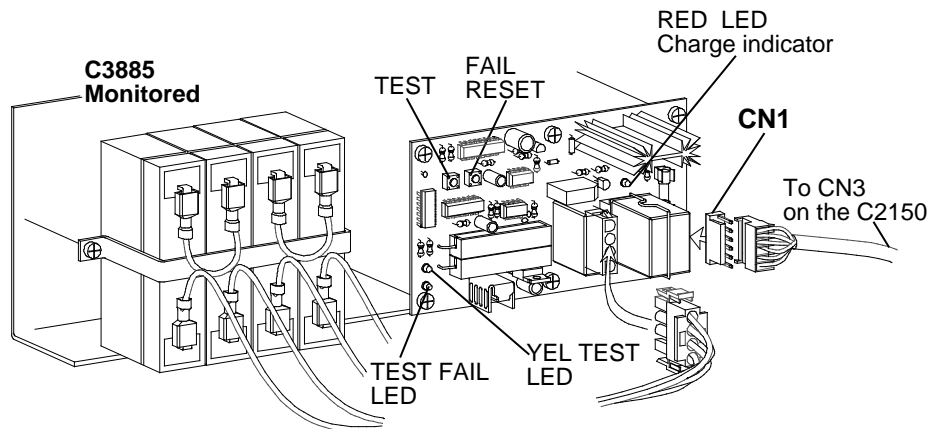

### Monitored power fail unit

This unit automatically tests its batteries at startup and at least once an hour afterwards.

- If the batteries test fails during daytime operation it will go to full open position (as per European standard) and stay open. The C2150 display will flash bF until the failure is corrected.
- To maintain security, battery failures are ignored in the night mode, but the failure is stored on the units circuit board. When the door is switched to the day mode it will open fully and indicate the failure on the C2150 display.

### Manual test

- Press and hold the test button on the circuit board until the yellow LED test indicator comes on, then release it. The pack is now self testing to insure that enough power is available to open or close the door for one cycle. If the test is OK the indicator will go out in about 15 seconds and the red charge indicator will come on. It will glow for about 5-7 minutes, then dim and go out. (Assuming the batteries were fully charged when the test was started).

# DIAGRAM 1 C2150 TYPICAL WIRING for 2000 LINEAR DRIVE

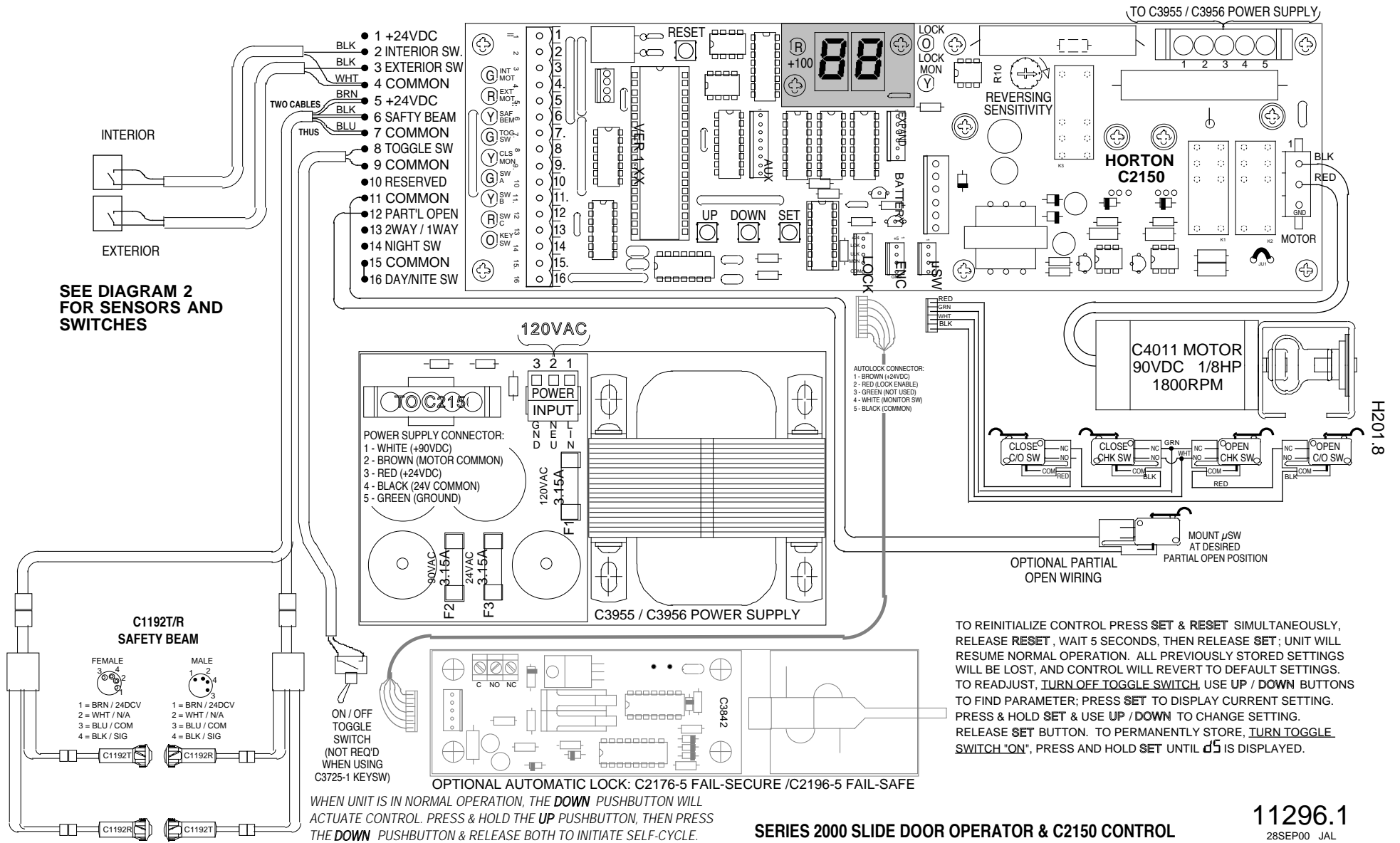

SEE DIAGRAM 2 FOR SENSORS AND SWITCHES

TO REINITIALIZE CONTROL PRESS **SET** & **RESET** SIMULTANEOUSLY, RELEASE **RESET**, WAIT 5 SECONDS, THEN RELEASE **SET**; UNIT WILL RESUME NORMAL OPERATION. ALL PREVIOUSLY STORED SETTINGS WILL BE LOST, AND CONTROL WILL REVERT TO DEFAULT SETTINGS. TO READJUST, TURN OFF TOGGLE SWITCH, USE **UP** / **DOWN** BUTTONS TO FIND PARAMETER; PRESS **SET** TO DISPLAY CURRENT SETTING. PRESS & HOLD **SET** & USE **UP** / **DOWN** TO CHANGE SETTING. RELEASE **SET** BUTTON. TO PERMANENTLY STORE, TURN TOGGLE SWITCH "ON", PRESS AND HOLD **SET** UNTIL **ds** IS DISPLAYED.

WHEN UNIT IS IN NORMAL OPERATION, THE **DOWN** PUSHBUTTON WILL ACTUATE CONTROL. PRESS & HOLD THE **UP** PUSHBUTTON, THEN PRESS THE **DOWN** PUSHBUTTON & RELEASE BOTH TO INITIATE SELF-CYCLE.

SERIES 2000 SLIDE DOOR OPERATOR & C2150 CONTROL

11296.1  
28SEP00 JAL

**DIAGRAM 2 ACTUATING and CONTROL SWITCH CONNECTIONS**

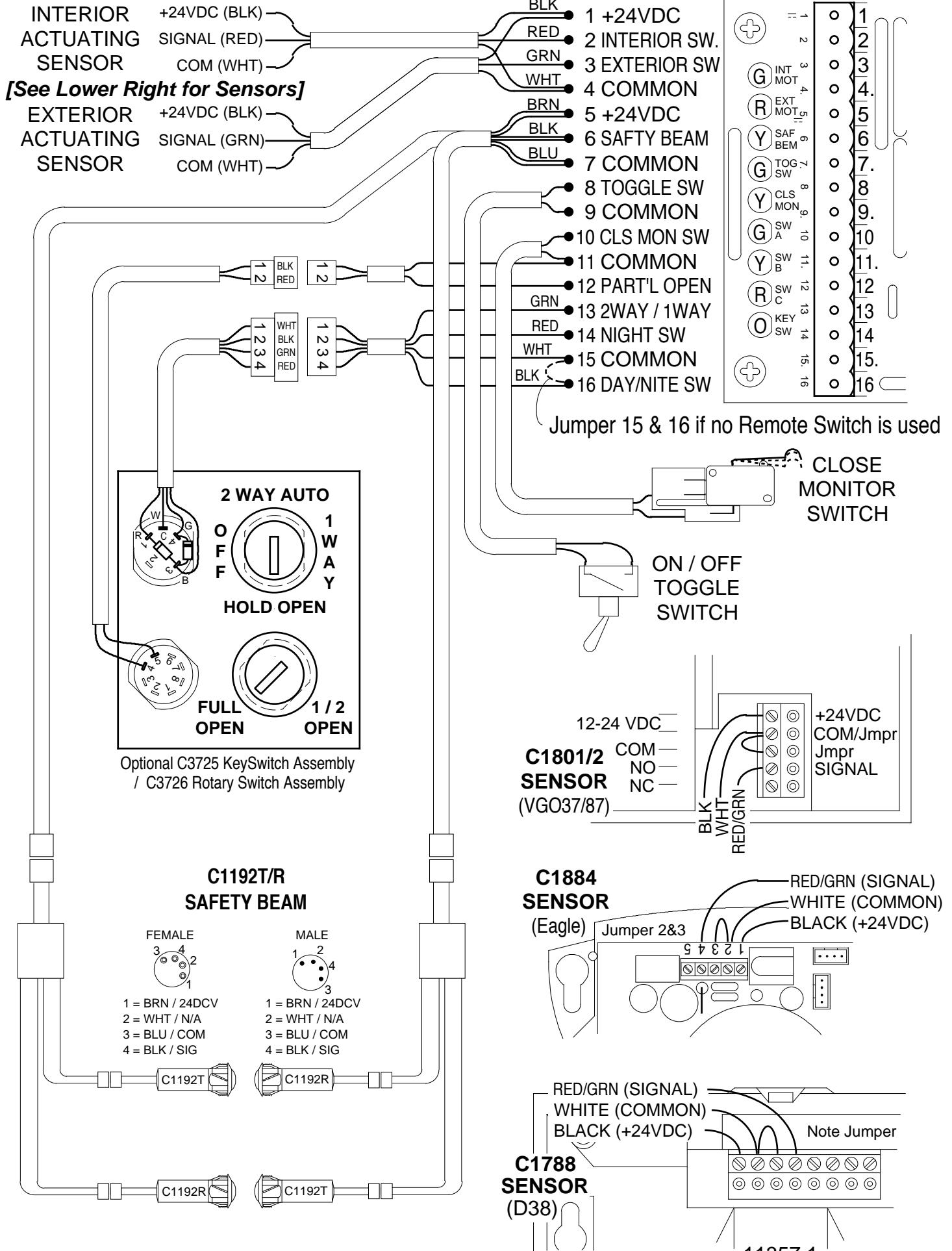

## APPENDIX A IN CASE OF DIFFICULTY

### 1.If DISPLAY FAILS TO LIGHT

- Go to section 1 step 8 and check for DC voltages shown on CN7 terminals 3&4.
- If voltage is **not present**, check AC power at pins 1&2 of CN1 of power supply.
- If AC power is **present**, check fuses F1 & F3 of the power supply.

### 2.If DISPLAY LIGHTS, BUT DOOR NEVER MOVES

- Go to section 1 step 8 and check for DC voltages shown on CN7 terminals 1&2.
- If voltage is **not present**, check fuse F2 of the power supply.
- If F2 is good power supply is faulty.
- If voltage is **present** on CN7 and display is showing a run code ie:  $\overline{05}$ ,  $\overline{04}$ ,  $\overline{15}$ ,  $\overline{11}$  or  $\overline{14}$  check for motor voltage (with motor plugged in) on pins 1 and 2 of CN8 leaving the control. Use 200 VDC scale.
- If voltage is **not present** at CN8, change control.
- If voltage is **present** at CN8, go to appendix C for motor test.

### 3.DOOR SLAMS OPEN and / or CLOSED WITH NO SPEED CONTROL

- Go to appendix C for motor test ( to make sure motor did not ruin control)
- If motor test good, change control.

### 4.DISPLAY WILL ONLY SHOW OS

- Make sure toggle circuit is complete by turning toggle switch off and on. The green TSW LED should go off and come back on. This LED must be on for the door to operate.

### 5.ERROR CODE OR SOME OTHER ABNORMAL DISPLAY APPEARS.

- Go to appendix A - find the code and follow the instructions.

### 6.FUSE F2 BLOWS REPEATEDLY

**CAUTION:** disconnect the power supply at CN1 and wait 30 seconds before servicing.

- Unplug the power harness at CN7 (section 1 step 8) and the motor at CN8 and replace the fuse (slow blow 5 x 20mm Buss type GDC 3.15 or equal )
- If the fuse blows again, replace the power supply.
- If the fuse does not blow, reconnect the power harness at CN7 and attempt to operate the door with the motor unplugged.
- If the fuse blows now, replace the C2150 control (first check motor as shown in appendix C).
- If the fuse does not blow, plug the motor in and try again.
- If the fuse blows again and the motor checked good, check for a mechanical bind. Check the  $\overline{b}$  parameter in appendix A which can help prevent fuse blowing.
- Consult Technical Assistance at the Horton factory.

### 7.FUSE F3 BLOWS REPEATEDLY

**CAUTION:** disconnect the power supply at CN1 and wait 30 seconds before servicing.

- Unplug the power harness at CN7 (section 1 step 8) and all connections of pins 1 and 5 of CN2 and CN4 autolock, if present, and replace fuse F3 again (slow blow 5 x 20mm Buss type GDC 3.15 or equal )
- If the fuse blows again, replace the power supply.
- If the fuse does not blow, reconnect the power harness to CN7.
- If the fuse blows now replace the C2150 control.
- If the fuse does not blow replace the autolock, and connections at pins 1 and 5 of CN2 one at a time until F3 blows indicating a short circuit in that component or its wiring. Beams and their wiring are the most frequent cause of F3 failure.

### 8.DOOR WILL CLOSE BUT NOT OPEN

See microswitch test

### 9.DOOR WILL OPEN BUT NOT CLOSE

See microswitch test

### 10.DOOR FAILS TO GO TO EITHER OPEN OR CLOSE CHECK

See microswitch test

**APPENDIX B1 CODE DISPLAYS** Codes are arranged in alphanumeric order (NOTE: D = Display, P = Parameter, E = Error)

CODE	DISPLAY MEANING	TYPE	VERSION
≡≡	Control is braking - door always brakes when opening. Close braking can be turned on at the <b>Ⓛb</b> parameter	D	1.00 △
<b>BB</b>	Control has failed - must be replaced	E	1.00
<b>1d</b>	Door is idle in <b>1</b> way <b>d</b> ay mode. See section 5	D	1.17
<b>1n</b>	Door is idle in <b>1</b> way <b>n</b> ight mode. See section 5	D	1.17
<b>2d</b>	Door is idle in <b>2</b> way <b>d</b> ay mode. See section 5	D	1.17
<b>2n</b>	Door is idle in <b>2</b> way <b>n</b> ight mode. See section 5	D	1.17
<b>RR</b>	Door was activated or is being held open by SW 'C' input. See App. D CN2 for wiring & LED	D	1.00
<b>RL</b>	This parameter is factory set - do not change without consulting factory	P	1.00
<b>Rd</b>	Use only with APEX system - see APEX instruction G550	P	1.16
<b>R1</b>	Use only with APEX system - see APEX instruction G550	P	1.16
<b>RP</b>	To activate this APEX feature you must - turn the parameter on - do a data save, and then press reset only	P	1.16
<b>RS</b>	When <b>Auto Seal</b> parameter is turned on, the display will change to <b>RS</b> and the control will try to close the door every 15 seconds	PD	1.00
<b>RU</b>	Use only with APEX system - see APEX instruction G550	P	1.17
<b>bF</b>	This indicates battery failure of C3985 monitored power failure unit - see section 14	E	1.00
<b>b1</b>	Use only with APEX system - see APEX instruction G550	P	1.17
<b>bL</b>	<b>bi</b> stable <b>L</b> ock - no longer used	P	1.00
<b>br</b>	<b>B</b> rake on recycle turned on, the control will slow door substantially before reversing on recycle	P	1.02
<b>bt</b>	Determines how long control brakes motor after open speed	P	
<b>Ⓛb</b>	When <b>close braking</b> parameter is turned on, the control brakes the door after close speed - recommended for heavy doors	P	1.02
<b>ⓁⓁ</b>	<b>C</b> lose <b>C</b> heck speed - see section 2, step 8	PD	1.00
<b>Ⓛd</b>	Use only with APEX system - see APEX instruction G550	D	1.17
<b>ⓁE</b>	APEX communication error - if using APEX then turn AP on	D	1.17
<b>ⓁL</b>	Power fail <b>C</b> lose see section 14	D	1.09
<b>ⓁP</b>	This parameter determines stroke to open check. Adjustable from 50-90% of total stroke	P	1.00
<b>ⓁS</b>	<b>C</b> lose <b>S</b> peed see section 2 step 8	PD	1.00
<b>Ⓛt</b>	<b>C</b> ycle <b>t</b> est will cause door to open and close repeatedly for test purposes	PD	1.00
<b>ⓁU</b>	<b>C</b> lose <b>C</b> ushion speed (see section 2 step 8)	PD	1.00
<b>d1</b>	Main time delay- starts when all activate and recycle inputs clear and door is fully open	PD	1.00
<b>d2</b>	Partial open delay is active when SW 'A' is on (App. D) & starts when all activate and recycle inputs have cleared & door is at partial open	PD	1.00
<b>dR</b>	Door idle in <b>dA</b> y mode.(Has been replaced in later software by <b>1d</b> or <b>2d</b> parameter see section 5	D	1.16
<b>dF</b>	Control failed to store parameters (control must be replaced)	E	1.15
<b>dL</b>	<b>D</b> oor <b>L</b> ocks (in day mode ) when this parameter is turned on. See section 7	D	1.00
<b>dn</b>	This is a cycle code (see foot note ) from <b>D</b> OWN button		1.14
<b>dS</b>	This shows a successful Data Save. See section 3 step 10	D	1.00
<b>ER</b>	This is a cycle code (see foot note ) from ext motec input see appendix D CN2	D	1.14
<b>Er</b>	Use only with APEX system - see APEX instruction G550	DP	1.16
<b>EU</b>	Use only with APEX system - see APEX instruction G550	D	1.16

H201.11

## APPENDIX B2 CODE DISPLAYS

CODE	DISPLAY MEANING	TYPE	VERSION
Hd	This parameter should be turned on when using a 1/4 HP motor and a light door. (Reduces abruptness of closing )	D	1.08
hh	Use only with APEX system - see APEX instruction G550	P	1.16
h l	Use only with APEX system - see APEX instruction G550	P	1.16
HL	Use only with APEX system - see APEX instruction G550	P	1.16
HD	This parameter is factory set - do not change without consulting the factory	P	1.00
#R	This is a cycle code (see foot note) from Interior Motec see appendix D CN2	D	1.00
#F	Use only with APEX system - see APEX instruction G550	P	1.14
lr	Use only with APEX system - see APEX instruction G550	P	1.16
UU	Use only with APEX system - see APEX instruction G550	P	1.16
L l	Provides Locking in 1 way mode (see section 7)	P	1.02
LF	Automatic Lock Failed to lock (see section 8)	E	
Lh	Use only with APEX system - see APEX instruction G550	P	1.16
LL	Shows lock is present (see sect. 6)	P	1.00
Lt	When turned on triples time in open and close before <b>LO</b> occurs	P	1.17
Lo	Use only with APEX system - see APEX instruction G550	P	1.16
nR	Access restricted call factory for assistance	PD	1.04
nL	No Lock found during initialization (see section 6)	D	1.00
nS	Door has not reached close cut off switch. See sect. 1 step 2. Check for obstructions. See appendix A step 2	E	1.06
nt	Door idle in night mode (Replaced in later versions by 1n & 2n) see sect. 2, step 8	D	1.17
OC	Open Check speed (see sect.2 step 8)	PD	1.00
OP	This is a Power fail Open code (see sec.13)	D	1.09
OS	Open Speed (see sect. 2 step 8)	PD	1.00
OU	Open cUshion speed (see sect. 2 step 8)	PD	1.00
PC	Indicates control is slowing for partial open	D	1.00
PF	Power Failure (see sect. 13)	PD	
Pn	Power failure (see sect. 13)	P	1.12
rL	This parameter is factory set - do not change without consulting factory	P	1.00
rn	Use only with APEX system - see APEX instruction G550	P	1.16
rU	This is a cycle code (see foot note) from reverser circuit.	D	1.17
SR	Indicates fail SAfe lock is found during initialization (see sect. 6 ) Parameter should be turned on if a fail safe lock is present.	PD	1.00
Sb	This is a cycle code (see foot note) from safety beam input.	D	1.17
SE	Indicates fail SEcure lock is found during initialization (see sect. 6 )	D	1.00
S l	Use only with APEX system - see APEX instruction G550	P	1.17
SP	Provides Sidelite Protection when turned on. Reduces opening speed to open check when safety beam input is activated (see app D)	P	1.17
SU	Displays at beginning of initialization (see sect 2, step3 in ver 1.17and up)	D	1.17

H201:12

## APPENDIX B3 CODE DISPLAYS

CODE	DISPLAY MEANING	TYPE	VERSION
<b>Ed</b>	This display indicates door did not reach the expected switch in time allotted	D	1.00
<b>Ud</b>	Use only with APEX system - see APEX instruction G550	P	1.16
<b>UF</b>	Autolock has failed to unlock (see sect 8)	E	1.00
<b>UL</b>	When this is turned on it tells the software not to wait for the lock monitor but try to open after a brief delay. Rarely used, only for non Horton locks	P	1.00
<b>Un</b>	Use only with APEX system - see APEX instruction G550	P	1.16
<b>US</b>	Use only with APEX system - see APEX instruction G550	P	1.16
<b>Ut</b>	Brief display code at start of microswitch test (see sect.11)	D	1.00

### FOOT NOTES:

•The latest versions, 1.14 and up, also have a new feature called cycle / hold codes. Immediately after the door has opened to its stopping point (full or partial open), a "cycle code" will flash briefly. This code indicates which device opened the door. The cycle code is useful if a door is ghosting and you are trying to figure out which activating device is causing the problem.

•If an actuator is holding the door open, the updated software shows a "hold code" instead of **d1** or **d2**, to indicate which device is holding the door open, The displays shows the various hold codes in sequence. When all devices are clear, the display will switch to **d1** or **d2** and the normal time delay will start.

#### The cycle / hold codes used are:

- iR** Interior Actuator (pin 2 of CN 2)      **dn** down button
- Sb** Safety beam (pin 6 of CN 2)      **RR** Auxiliary Actuator (pin 14 of CN 2)
- ER** Exterior Actuator (pin 3 of CN 2)      **rU** ReVerser (cycle code only)

•While the door is at rest in the open position, pressing and holding the **UP** button will switch the display to show the last cycle code; that is, the last device that cycled (or recycled) the door. Releasing the **UP** button takes you right back to normal operation. This is a kind of "mini-history" in case you didn't see the cycle code when the control flashed it the first time.

### SHORT CUTS

**SELF CYCLE MODE** To initiate self cycle without accessing the **ct** parameter press and hold the **UP** button then press the **DOWN** button and release them at the same time. If you haven't saved any parameters, you can get out of this mode by pressing the **RESET** button only. Otherwise you must go to the **ct** parameter and turn off and do a data save.

**CYCLE DOOR** Push the **DOWN** button. The door will open, and stay open until **d1** expires and then close.

**LINEAR TRAVEL BLOCK ADJUSTMENT** press and release **RESET** while holding **UP** & **DOWN** simultaneously for five seconds. Motor will run in closed position to allow tension to be set on the drive block.

**RETURN TO THE TOP OF THE MENU**(Version 1.08 and later) Press **UP** and **DOWN** together to return to the top of the menu.

**PARAMETER ACCESS** (Version 1.10 and later) The menu may be accessed and parameters changed by rapidly double clicking the **SET** button when the door is fully closed or opened. To exit double click the **SET** button again and the control will return to normal mode. Turning the toggle off and on will override this function.

## APPENDIX C WIRING DIAGRAM LIST

DRAWING No.	BEAMS		ACTIVATE				KEY SW		AUTO-LOCK	
	C&K C1185	4 BEAM C1284	C&K C1188-1	VGO37 C1801	VGO87 C1802	CPSS12	C3725-L 4 POS	PARTL OPEN	9766	
11100.0 *	X		X							
11100.1 *	X			X						
11101.1 *	X		X				X			
11104.1 *	X		X				X	X		
11105.0 *	X		X							5 Position SW
11238.1 *	X			X					X	Security panel C1280
11229.0 *		X		X					X	
11231.0 *		X		X						C3881 w/ mag lock
11247.0 *	X			X						Limited access
11249.1 *	X					X	X			

\* These drawings are for a belt drive application and show a close monitor switch, however, they may be useful to wire up beams and motion detectors.

H201.13

**APPENDIX D TERMINAL CN2**

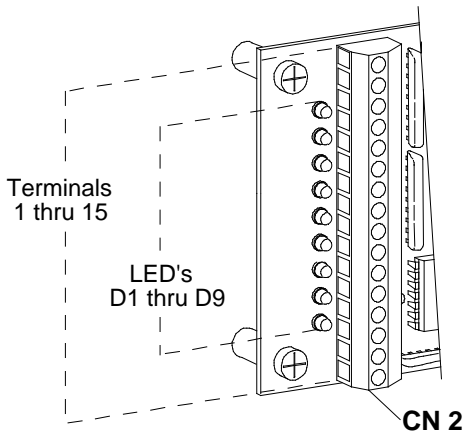

**NOTE:**

- == This symbol indicates 24 volts DC
- 4. A point behind a number indicates common (ground)

LED	TERMINAL	DESCRIPTION
	== 1	24 VDC
D1 (G) INT MOT	2	Interior Activation
D2 (R) EXT MOT	3	Exterior Activation
	4.	Common
	== 5	24 VDC
D3 (Y) SAF BEM	6	Safety beam & sidelite protection (After Ver 1.17)
	7.	Common
D4 (G) TOG SW	8	Toggle switch
	9.	Common
D5 (Y) CLS MON	10	Sidelite protection (Ver. 1.00/1.16) Partial open cutoff 1.17 & later (see sect 12)
	11.	Common
D6 (G) SW A	12	Partial open cutoff (See sect 12)
D7 (Y) SW B	13	1 Way (Closed for one way- light on)
D8 (R) SW C	14	Auxillary activation
	15.	Common
D9 (O) KEY SW	16	Day night mode (closed for day mode- light on)

**APPENDIX E MOTOR TEST**

This test is conducted to determine the resistance across the motor. A low or zero resistance will cause high current draw and damage to the control.

- Place OHM meter in range to measure : 10 to 50 analog Rx1 range R200 digital.
- Unplug the motor and place probes in pins 1 and 2
- Read and record the resistance.

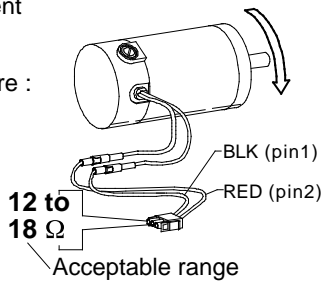

NOTE: A low reading is critical and will cause damage to the control.

- Rotate the motor a little bit to move to the next section of the commutator. (Feel for the brushes to make contact with the next segment on the commutator.)
- NOTICE: a voltage will be induced into the meter when the motor is moved, so wait for the meter to stabilize before taking a reading.
- Continue taking readings for 1 revolution

**FRAME SHORT TEST**

- Place the OHM meter in the range to measure at least 20,000 . The meter should show infinite resistance when connected .

- Place one probe in pin 1 (BLK) and one probe on the motor case.

THEN... The meter should not move when the probes are connected.

- Place one probe in pin 2 (RED) and one probe on the motor case.

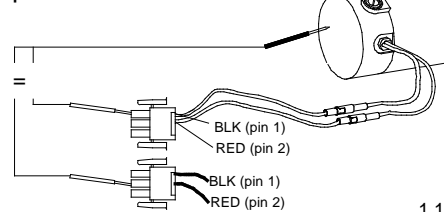

1.153d1



4242 Baldwin Boulevard  
 Corpus Christi  
 Texas 78405-3399  
 800-531-3111  
 361-888-5591  
 Fax: 800-531-3108 361-888-6510  
 Internet: <http://www.hortondoors.com>

Horton Automatics, Ltd.  
 Unit A, Hortonwood 31  
 Telford, Shropshire  
 England TFI-4GS  
 01952 670169  
 Fax: 01952 670181  
 International Telephone ++44-1952 -670169  
 Fax: ++44-1952-670181

Form H201, JAN 01  
 1999 Horton Automatics, printed in U.S.A.

Product equipment depicted in the various figure drawings are approximate and for illustration purposes only. Consult manufacturer for detail product specifications. Horton Automatics reserves the right to improve the product and change its specifications without notice.